

## Cables and Connectors

[www.heidenhain.com](http://www.heidenhain.com)

Precision encoders require reliable transmission between the encoder and the downstream electronics. A key role in this is played by the cable and connecting element technology employed.

HEIDENHAIN provides non-assembled, partially assembled and fully assembled **cables** as encoder accessories that are optimized for the given type of signal transmission (i.e., for specific interfaces). At the same time, special attention has been paid to the operating conditions. HEIDENHAIN cables are subjected to extensive system testing in order to ensure that they meet stringent requirements.

HEIDENHAIN **connecting elements** ensure long-term signal transmission with uninterrupted shielding and low transition resistance. Their rugged and tightly sealed designs makes them ideal for harsh operating conditions.



 **Further information:**

For detailed descriptions of all available interfaces, as well as general electrical information, please refer to the *Interfaces of HEIDENHAIN Encoders* brochure.

Further cables and connecting elements for controls can be found in the OEM brochures for the respective controls.

*This brochure supersedes all previous editions, which thereby become invalid. The basis for ordering from HEIDENHAIN is always the brochure edition valid when the order is placed.*

*Standards (ISO, EN, etc.) apply only where explicitly stated in the brochure.*

# Contents

Technical characteristics		
HEIDENHAIN cables and connectors	Areas of application	4
	Terminology for HEIDENHAIN pre-assembled cables	5
General information	Durability and bending characteristics	6
	Cable lengths	7
	Information on output cables	8
	General testing accessories for modular encoders and the PWM 21	9
	Usage in drag chains	10
Connecting elements on HEIDENHAIN cables	Overview of connecting elements	11
HMC 2 and HMC 6	Single-cable solution for servomotors	16
Cable overviews		
Example of a cable configuration		18
Symbols used in the cable overviews		20
Adapter cables and connecting cables	<ul style="list-style-type: none"> <li>– EnDat (EnDat22)</li> <li>– DRIVE-CLiQ</li> <li>– Fanuc Serial Interface</li> <li>– Mitsubishi high speed interface</li> <li>– Panasonic Serial Interface</li> <li>– Yaskawa Serial Interface</li> <li>– EnDat (EnDat0x) or SSI</li> <li>– 1 V<sub>PP</sub></li> <li>– TTL or HTL</li> <li>– 11 μA<sub>PP</sub></li> <li>– Touch probes with EnDat or HTL</li> <li>– Touch probes</li> <li>– Digital readouts</li> <li>– Evaluation units</li> </ul>	21
Output cables	<ul style="list-style-type: none"> <li>– HMC 2 (E30-R2)</li> <li>– HMC 6 (EnDat22)</li> <li>– EnDat (EnDat22)</li> <li>– EnDat (EnDat01)</li> <li>– DRIVE-CLiQ</li> <li>– 1 V<sub>PP</sub> or TTL</li> </ul>	40
Cable list		
Information about the cable list		47
Cable list sorted by ID number		48
Signal cables		75
Connecting elements		
Connecting elements	M12 and M23 connecting elements	76
	D-sub and HMC 6 connecting elements	78
	HMC 2 connecting elements	80
Pin layouts		82

# HEIDENHAIN cables and connectors

## Areas of application

HEIDENHAIN cables and connecting elements, in conjunction with the given encoders, are deployed in a wide range of industrial production applications, as well as in applications for the medical technology field, metrology laboratories and positioning devices. The requirements for the cables vary based on the type of application:

### Machine tools

- Resistant to media
- Suitable for drag chains
- Connectable to the encoder for easy replacement
- Convenient routing

### Electronics industry

- Small bend radius
- High bending frequency
- Low bending force

### Metrology

- Low bending force
- Convenient routing

### Automation technology

- Long cable lengths
- Convenient routing
- High bending frequency
- Compact connecting elements

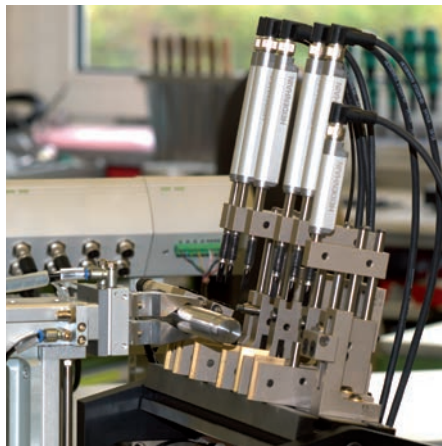

HEIDENHAIN cables and connecting elements are specially designed to meet the requirements of these areas of application. Functionality and durability are inspected through extensive testing.

Here are the advantages of HEIDENHAIN cables and connecting elements at a glance:

### Connecting elements

- Low contact resistance
- Reliable shield connection
- Continuous shielding throughout
- Corrosion-free contacts
- Reliable contact closure
- Long-term ruggedness

### Cables

- Low crosstalk
- Good shield coverage
- Small bend radius
- Suitable for drag chains
- Resistant to media
- Mechanically rugged
- Adapted wire cross section
- Resistant to aging

# Terminology for HEIDENHAIN pre-assembled cables

“Pre-assembled cable” is a hypernym referring to cables used for connecting devices such as a control and an encoder. Depending on which connecting elements are assembled at the ends, pre-assembled cables are divided into connecting, adapter and output cables.

## Cable length

The length of a pre-assembled cable is the length of its insulated section between both connectors or cable ends. Please also note the specified cable length for output cables (see *Information on output cables*).

## VBK = Connecting cable



Cables that use the same type of connecting element at both ends, as well as cables with a free cable end, are referred to as connecting cables. This nomenclature applies regardless of whether the connecting elements are connectors or couplings and whether they are male or female, and so also applies to extension cables.

## Example

8-pin M12 connector with female contacts and an 8-pin M12 coupling with male contacts.



## APK = Adapter cable



Cables with different connecting elements at each end are referred to as adapter cables.

## Example

8-pin M12 connector with female contacts and a 15-pin D-sub connector with male contacts.



## AGK = Output cable



Output cables are assemblies that directly connect to the PCB connector of an encoder on one end and convert to a different connecting element system or a free cable end on the other.

## Example

Rotary encoder cable assemblies for use inside the motor housing; for conversion from a PCB connector to a 9-pin M23 angle flange socket.



# General information

## Durability and bending characteristics

### Versions

The output cables of nearly all HEIDENHAIN encoders,<sup>1)</sup> as well as the adapter cables and connecting cables, feature a **polyurethane (PUR)** jacket. Other materials used are **special elastomer (EPG)**, **special thermoplastic (TPE)** and **polyvinyl chloride (PVC)**. These cables are identified in the brochure as PUR, EPG, TPE or PVC.

### Durability

**PUR cables** are oil-resistant in accordance with DIN EN 60811-404, as well as hydrolysis- and microbe-resistant in accordance with DIN EN 50363-10-2. They are free of PVC and silicone, and comply with UL safety regulations. The **NRTL certification** is indicated by the following label: AWM STYLE 20963 80°C 30V.

**EPG cables** are suitable for higher temperature ranges and are oil-resistant in accordance with DIN EN 60811-404, as well as hydrolysis-resistant in accordance with DIN EN 50363-10-2, and are free of PVC and silicone. The jacket is free of halogens in accordance with IEC 60754-1. Compared with PUR cables, their resistance to media, frequent flexing, and continuous torsion is more limited.

**PVC cables** are oil-resistant. The NRTL certification is indicated by the following label: AWM STYLE 20789 105C VW-1SC NIKKO.

**TPE wires** in netting or heat shrink tubing are suitable for higher temperature ranges and low bending radii, but they exhibit only low oil-resistance.

### Temperature range\*

	Rigid configuration	Frequent flexing
PUR	-40 °C to 80 °C	-10 °C to 80 °C
EPG	-40 °C to 120 °C	-
ETFE	-65 °C to 125 °C	-
TPE	-40 °C to 120 °C	-
PVC	-20 °C to 90 °C	-10 °C to 90 °C

\* Values may vary in individual cases

Some PUR cables can be used at temperatures of up to 100 °C, provided that the exposure to hydrolysis and media is low. If you need assistance, please contact HEIDENHAIN.

**ETFE wires**, twisted (signal wires) or in heat-shrink tubing (temperature sensor), are highly resistant to oils, greases, acids, bases and solvents, and do not contain PVC or silicone.

### Bending characteristics

The **bend radii** of the cables differ based on whether they are used in a fixed installation or whether they are subjected to frequent flexing (e.g., in a drag chain). The minimum permissible bend radius is contingent on the cable diameter and cable jacket.

The **flexing frequency** of HEIDENHAIN cables is tested in continuous tests.

The **bending force** is a decisive criterion for applications in which no applied force is permitted (e.g., extremely fast or high-accuracy positioning tasks). The pre-assembled cable used for the connection between the stationary part and the moving part must

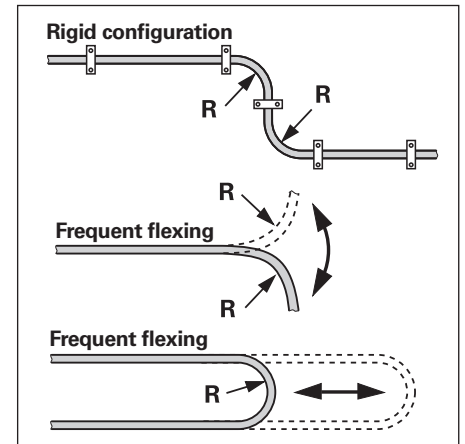

therefore be highly flexible so as to prevent bending in the measuring setup due to the bending force of the cable. For such applications, HEIDENHAIN provides extremely thin cables with a bending force that is sufficiently low for frequent flexing.

Cable	Material	Bend radius R	
		Rigid configuration	Frequent flexing
Ø 3.7 mm	EPG	≥ 10 mm	-
Ø 3.7 mm	PUR	≥ 8 mm	≥ 40 mm
Ø 4.3 mm		≥ 10 mm	≥ 50 mm
Ø 4.5 mm			
Ø 4.5 mm	EPG	≥ 18 mm	-
Ø 5.1 mm	PUR	≥ 10 mm	≥ 50 mm
Ø 5.5 mm	PVC	Upon request	Upon request
Ø 6.0 mm	PUR	≥ 20 mm	≥ 75 mm
Ø 6.8 mm			
Ø 8.0 mm		≥ 40 mm	≥ 100 mm
Ø 10 mm, Ø 11.1 mm <sup>2)</sup>		≥ 35 mm	≥ 75 mm
Ø 14 mm <sup>2)</sup>		≥ 100 mm	≥ 100 mm
6 or 8 TPE wires in netting or heat shrink tubing	TPE	≥ 10 mm	-
2 TPE wires in heat shrink tubing		≥ 3 mm	-
2 polyolefin wires in heat shrink tubing	Polyolefin in net sleeve	≥ 5 mm	-
2 twisted ETFE wires	ETFE	≥ 5 mm	-

<sup>1)</sup> In the following, "encoders" refers to HEIDENHAIN encoders and HEIDENHAIN signal converters

<sup>2)</sup> Diameter of the protective metal sleeve with cable on the inside

# Cable lengths

## Maximum cable lengths

The interfaces of the HEIDENHAIN encoders permit long cable lengths of up to 150 m in some cases. The cable lengths in the specifications of HEIDENHAIN encoders or in the *Interfaces of HEIDENHAIN Encoders* brochure apply only to HEIDENHAIN cables and are significantly influenced by the following factors:

- Compliance with the supply voltage at the encoder
- Influence of input circuitry and the supply voltage of the downstream electronics
- Restrictions arising from the transmission technology (e.g., protocol design for purely serial interfaces and manufacturer specifications for proprietary interfaces)

Please note: These restrictions must be checked independently from each other and complied with.

## Compliance with the supply voltage at the encoder

Typical overall lengths of 30 m are attainable without restrictions. For larger overall lengths, connecting cables with a larger cross section must be used or, if possible, the supply voltage  $U_P$  of the downstream electronics should be increased.

Over large cable lengths, the voltage drop in the supply wires is high. The voltage drop is influenced by the cable length, the current consumption of the encoder, and the wire cross-section of the supply lines.

The voltage drop may cause the supply voltage to fall below its minimum permissible level, particularly in the case of long cable lengths and encoders with high current requirements, such as absolute linear and angle encoders. The highest possible supply voltage  $U_P$  should therefore be selected in the downstream electronics. The voltage drop can be mitigated through the following measures:

- Keep thin cables with small wire cross-sections as short as possible
- For long cable lengths, select a wider wire cross section
- For downstream electronics without a variable power supply unit, connect the sense lines in parallel with the supply lines. This doubles the available cross-section

## Data transfer technology

The transmission characteristics of the pre-assembled cables, protocol properties of the interfaces, and other specifications impose limitations on the design of the cable lengths.

An adapter cable connected directly to the encoder is limited in terms of its length. For implementing longer cable lengths, an additional pre-assembled cable can be used for longer transmission lengths.

The following restrictions must be observed depending on the interface and the cable diameter:

### EnDat 2.1, SSI, 1 V<sub>PP</sub> TTL interfaces:

- Adapter cable with 12-pin M12 quick connector or 14-pin M12 coupling; max. cable length of up to 9 m possible

### EnDat 2.2 (EnDat22), EnDat 3, Fanuc, Mitsubishi, Panasonic, Yaskawa purely serial interfaces:

In order to meet the growing demands placed on transmission technology in the future, suitable cables have been introduced for purely serial interfaces. These cables feature the following key advantages over the cables used up to now:

- Transmission characteristics optimized for future requirements
- Optimized suitability for use in drag chains

## Note:

Depending on the encoder, other length limitations may apply. For more information, see the brochure and Product Information document of the encoder in question.

# Information on output cables

Mounting and commissioning must be performed with appropriate ESD protection. Do not engage or disengage the connecting element when it is under power. To avoid overstressing the individual wires during disengagement of the connecting element, HEIDENHAIN recommends using the mounting aid for disconnecting the output cable.

## Strain relief

Avoid torque or tensile stress, and use strain relief wherever necessary.

## Straight M12 flange socket

Retention force of polarizing key:  
max. 1 Nm.

## Screws

For output cables with standard M12 or M23 flange sockets, use M2.5 screws.

The mounting method with M2.5 screws was designed for the following tightening torques:

For M12, M23:	min. $M_d$	0.4 Nm
	max. $M_d$	0.5 Nm
Load-bearing thread length:	min.	4 mm
Minimum tensile strength of the screws:		800 N/mm <sup>2</sup>

To prevent self-loosening of the screws, HEIDENHAIN recommends using a material bonding threadlocker.

## Accessory

**Mounting aid** for disengaging the output cable.

To avoid damaging the cable, use the mounting aid to connect and disconnect the output cable. Apply pulling force only to the connector of the cable assembly and not to the wires.

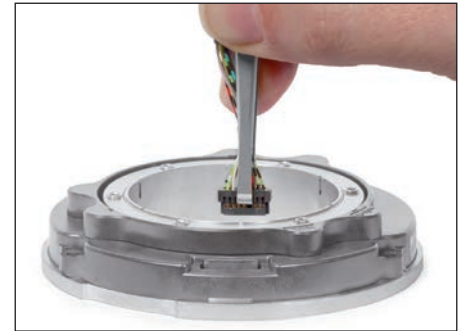

Mounting aid for output cable

## Cable length (rated length)

For output cables with a crimp on the encoder side for strain relief and a shield contact, the cable length is specified up to the crimp sleeve. Exceptions apply, for example, to output cables without a crimp on the encoder side and to those with a sensor connection at the downstream electronics or with a shield connection via a cable clamp. Upon request, you can obtain binding information (a dimension drawing) corresponding to the ID number of the respective output cable.

## Electromagnetic compatibility

Cables from HEIDENHAIN are tested for electromagnetic compatibility. For output cables with wires for temperature sensors, electromagnetic compatibility must be ensured in the entire system.

## Crimp connector

For joining (crimping) the wires of the temperature-sensor output cable to the wires of the temperature sensor inside the motor (ID 1148157-01).

## Designation of the cable components

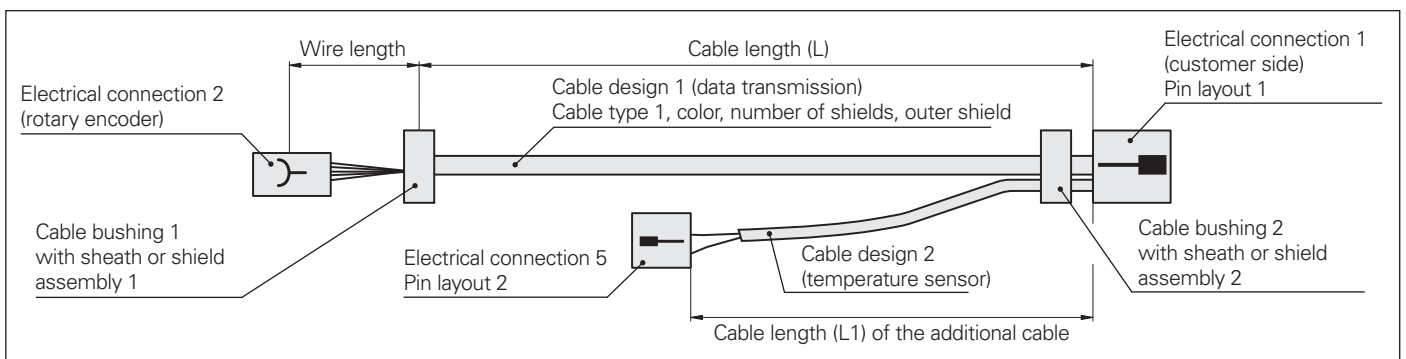

Temperature sensor signals via electrical connection 1

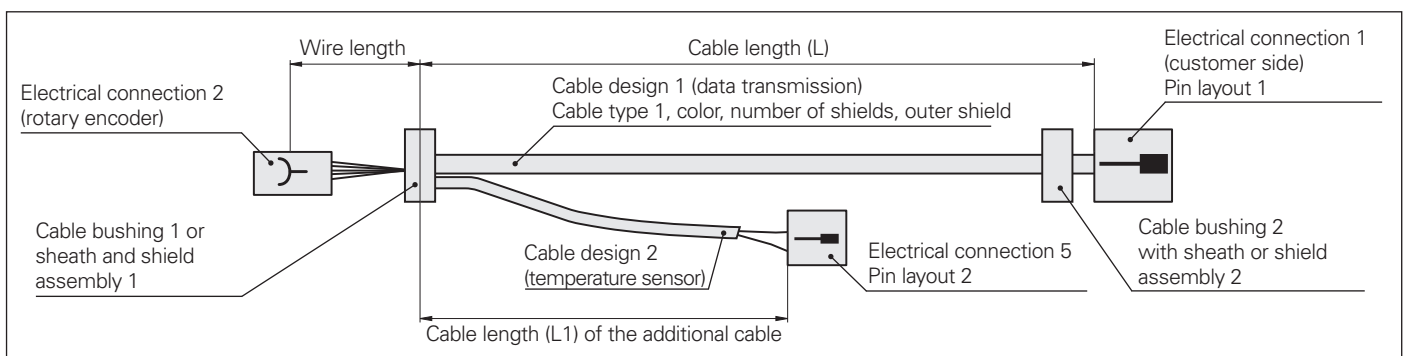

Temperature sensor signals via PCB of rotary encoder

# General testing accessories for modular encoders and the PWM 21

Testing cables are designed for use in lab and production sites but not for active industrial production.

## Testing cables for directly connecting a modular rotary encoder to a PWM 21

### Testing cable for modular rotary encoders with EnDat (EnDat22, EnDat01, or E30-R2) or SSI interface

Includes three 12-pin adapter connectors\* and three 15-pin adapter connectors.\*  
ID 621742-01

### Connecting cable for EnDat or SSI interface

For extending the testing cable; completely assembled with a 15-pin D-sub connector (male) and a 15-pin D-sub connector (female), max. 3 m  
ID 1080091-xx

### Adapter connector\* for ID 621742-01

Three connectors for replacement  
12-pin: ID 528694-01  
15-pin: ID 528694-02

\* Adapter connectors should be replaced after 500 connection cycles

## Adapter cables for connecting the flange socket on the motor to the PWM 21

### For the EnDat22 interface, adapter cable Ø 6 mm

9-pin M23 connector (female)  
8-pin M12 coupling (male).  
ID 1136863-xx  
(ID 524599-xx is additionally required:  
15-pin M12 (female) and  
15-pin D-sub connector (male))

### Adapter cables Ø 6 mm/8 mm

8-pin M12 connector (female) and  
15-pin D-sub connector (male).  
ID 1036526-xx Ø 6 mm  
ID 1129753-xx Ø 8 mm

### For the DRIVE-CLiQ interface, adapter cable Ø 6.8 mm

9-pin M23 connector (female)  
6-pin RJ45 Ethernet connector  
with IP20 metal housing.  
ID 1117540-xx

### Adapter cable Ø 6.8 mm

8-pin M12 connector (female)  
6-pin RJ45 Ethernet connector  
with IP20 metal housing.  
ID 1093042-xx

### Testing cable for the ERN 138xx, with commutation signals for sinusoidal commutation

Includes three 14-pin adapter connectors.\*  
ID 1118892-02

### Connecting cable for ERN 1387

For extending the testing cable  
Completely assembled with  
15-pin D-sub connector (male) and  
15-pin D-sub connector (female), max. 3 m.  
ID 675582-xx

### Adapter connector\* for ID 1118892-02

Three connectors for replacement  
14-pin: ID 528694-04

### Testing cable for modular rotary encoders with DRIVE-CLiQ interface

Includes three 12-pin adapter connectors\* and three 15-pin adapter connectors.\*  
ID 621742-01

### Only in connection with:

#### Adapter cable for DRIVE-CLiQ, Ø 6.8 mm

15-pin D-sub (female) and  
6-pin RJ45 Ethernet connector  
with metal housing (IP20)  
ID 1228399-01

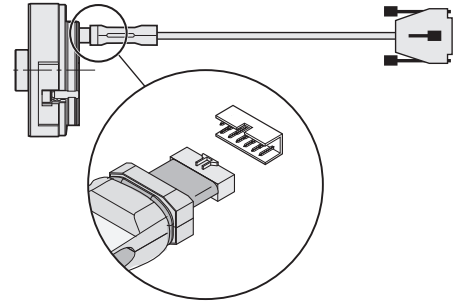

Testing cable for modular rotary encoders

### EnDat 3 adapter (SA 1210)

Adapter for connecting an encoder with EnDat 3 (E30-R2) to the PWM 21  
15-pin D-sub connector (male) and  
15-pin D-sub connector (female)  
ID 1317260-01



EnDat 3 adapter (SA 1210)

### EnDat 3 interface (E30-R2) for HMC 2, only in combination with EnDat3 adapter Adapter cable Ø 9.3 mm

M12 SpeedTEC hybrid connector (female),  
four power wires, two brake wires, and  
two communication wires  
15-pin D-sub connector (male).  
ID 1189174-xx

### Adapter cable Ø 9.3 mm

M23 SpeedTEC hybrid connector (female),  
four power wires, two signal wires, and  
two communication wires  
15-pin D-sub connector (male).  
ID 1275291-xx

### For EnDat01, EnDat Hx, EnDat Tx, or SSI interface with incremental signals, adapter cable Ø 8 mm

17-pin M23 connector (female) and  
15-pin D-sub connector (male).  
ID 324544-xx

### Adapter cable Ø 8 mm

12-pin M23 connector (female)  
15-pin D-sub connector (male).  
ID 310196-xx

### Version for HMC 6, adapter cable Ø 13.6 mm

M23 SpeedTEC hybrid connector (female),  
five power wires, two brake wires,  
and six communication wires, and  
15-pin D-sub connector (male).  
ID 1189174-xx

DRIVE-CLiQ is a registered trademark of Siemens AG.

SpeedTEC is a registered trademark of TE Connectivity Industrial GmbH.

# Usage in drag chains

## Encoder cables in drag chains

When properly routed, encoder cables from HEIDENHAIN are suitable for drag chains in machine tools or automation applications. These cables feature a typical service life of five to ten million cycles. A key factor for attaining this service life is compliance with the drag chain manufacturer's routing instructions and the routing information provided below. Incorrect routing or non-compliance with the routing instructions can significantly reduce the service life of the cables.

## Information for routing in drag chains

When used in drag chains, encoder cables are subjected to extremely high mechanical loads. The higher the traversing speed or number of cycles, the more stringently the routing instructions must be adhered to.

Routing information for the cable arrangement:

- Cables should be routed separately. As this is not always possible due to lack of space, cables with identical or similar diameters can be routed next to each other within the same compartment. Cables with widely varying diameters or cables made of different materials must be separated by vertical and horizontal separators
- The cables must not be permitted to shift over each other. In order to prevent such shifting, the clearance height of a compartment within the drag chain must not be greater than half of the cable diameter
- The space provided for the cables must be at least 10% to 20% of the cable diameter. This ensures the required freedom of movement for the cable

General routing information:

- The cables must be routed without twists. Unwind the cables from any drums or rings beforehand
- The cables must be able to move freely within the chain radius. Do not route the cables too tightly together or over an excessive distance
- Provide strain relief on both ends of each cable. Be sure to clamp it over as large an area as possible
- The weight should be distributed as evenly as possible in relation to the chain width

Routing information for bend radii:

- The minimum permissible bend radius of the chain is determined based on the permissible bend radius of all cables
- A bend radius that is larger than the minimum bend radius of the cables positively affects the service life of the cables. The bend radius should be chosen accordingly

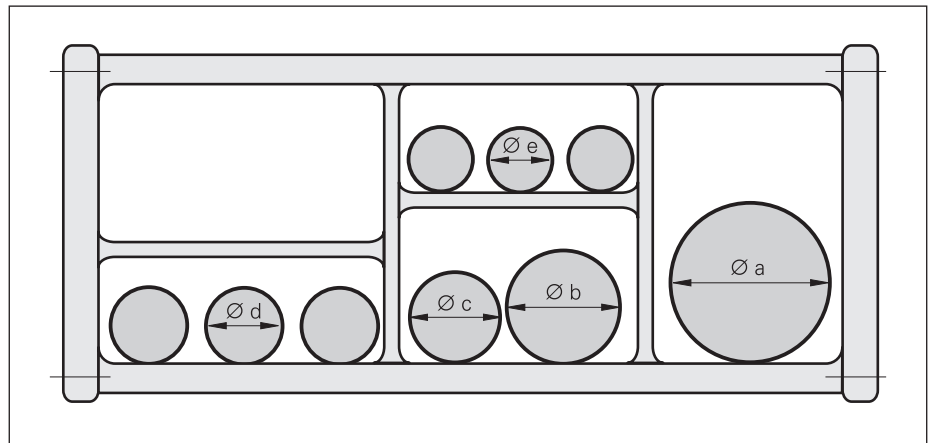

Configuration of a drag chain with cables of varying diameters ( $\varnothing x$ )

# Connecting elements on HEIDENHAIN cables

## Overview of connecting elements

Connecting elements are subdivided into the following:

Connector  
(with coupling ring)



Coupling  
(with external thread)



Please note: When tightening the M12 connectors, adhere to a torque of 0.6 Nm to 0.8 Nm. A torque wrench is separately available. Pre-assembled cables with an M12 connector (female) come with an insulator for preventing electrical contact

with other electrically conductive parts. After the connecting element has been tightened, the insulator must be inserted such that the inside wall lies between the knurled nuts.

**Plastic-insulated connectors:** connecting elements with coupling ring

**M12**

**M23**

**M12 right-angle connector**

**Quick connectors**  
M12, on the adapter cable

\* Cable fastening

**Connector with push-pull lock**

**Plastic-insulated couplings:** connecting element with external thread

**M12**

**M23**

**Coupling on the adapter cable**

**14-pin M12**

**Mounted coupling with flange**

**M23**

**Mounted coupling with central fastening**

**M23**

Mounting cutout

mm  
  
 Tolerancing ISO 8015  
 ISO 2768:1989 - m H  
 ≤ 6 mm: ±0.2 mm

Length of injection-molded connecting elements: ±2.5 mm

**Flange socket** with external thread:  
is fastened to a housing

**M23**

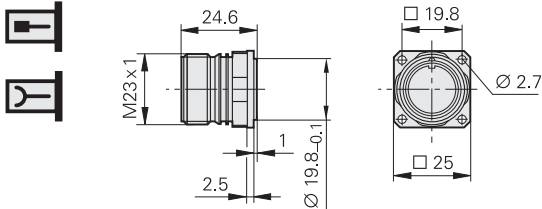

**Angle flange socket** (rotatable):  
With output cable for inside the motor housing

**M23**

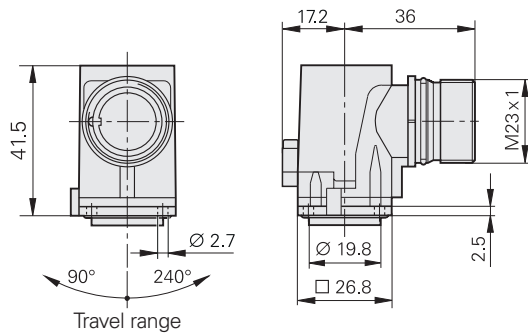

SpeedTEC **angle flange socket** (rotatable):  
With output cable for inside the motor housing

**M23**

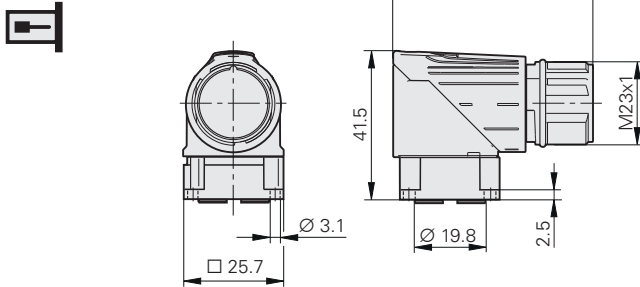

**Required mating dimensions for M12 and M23 flange socket**

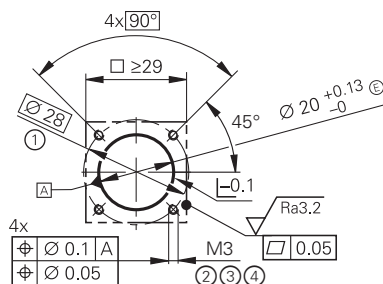

- 1 = Bolt circle diameter
- 2 = At least 3.5 mm of load-bearing thread
- 3 = Sealed blind hole or thread
- 4 = Tighten M3 screws with  $M_d = 0.8 \text{ Nm} \pm 0.05 \text{ Nm}$

**Flange socket for EnDat21/22:**  
With output cable for inside the motor housing

**M12**

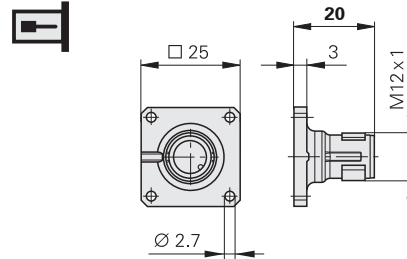

**Flange socket for DRIVE-CLiQ:**  
With output cable for inside the motor housing

**M12**

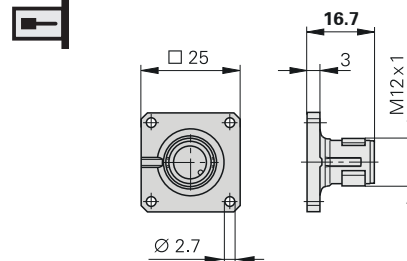

Output cables with a SpeedTEC angle flange socket always come with a mounted O-ring for vibration protection. They can therefore be used as connecting cables (VBK) with either a threaded connector (with O-ring) or a SpeedTEC connector (O-ring must be removed).

SpeedTEC is a registered trademark of TE Connectivity Industrial GmbH



Tolerancing ISO 8015  
ISO 2768:1989 - m H  
≤ 6 mm: ±0.2 mm

## Electrical connection 2 (rotary encoder) for output cable

16-pin (12+4)

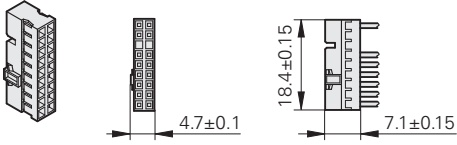

16-pin

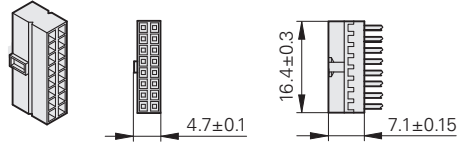

14-pin

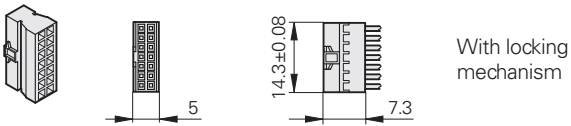

12-pin

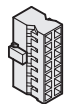
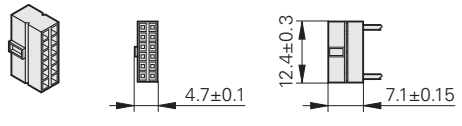

Without locking mechanism

4-pin

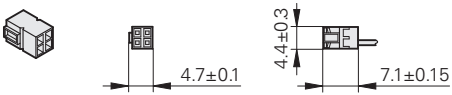

15-pin

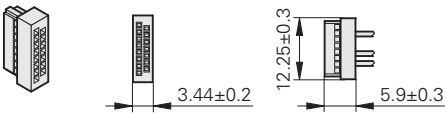

mm



Tolerancing ISO 8015  
ISO 2768:1989 - m H  
≤ 6 mm: ±0.2 mm

 **Further information:**

For more information, see *Information on output cables*

**HMC 2  
M23**

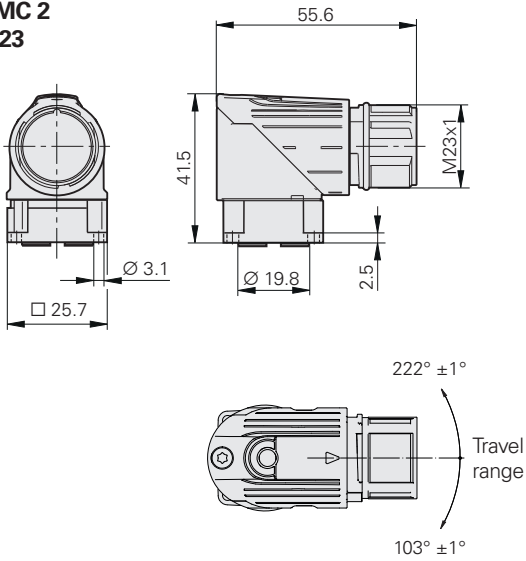

mm  
  
 Tolerancing ISO 8015  
 ISO 2768:1989 - m H  
 ≤ 6 mm: ±0.2 mm

**Required mating dimensions**

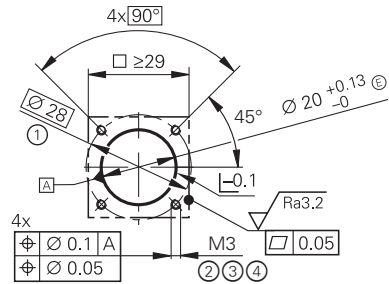

- 1 = Bolt circle diameter
- 2 = At least 3.5 mm of load-bearing thread
- 3 = Sealed blind hole or thread
- 4 = Tighten M3 screws with  $M_d = 0.8 \text{ Nm} \pm 0.05 \text{ Nm}$

**Connector**

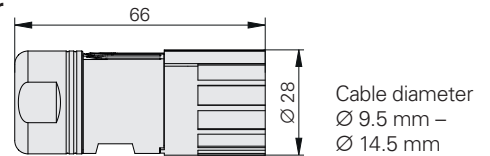

**Coupling**

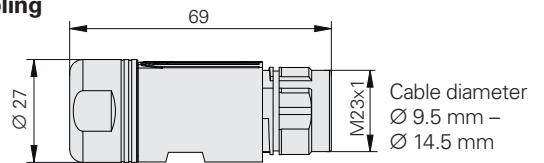

**HMC 2  
M12**

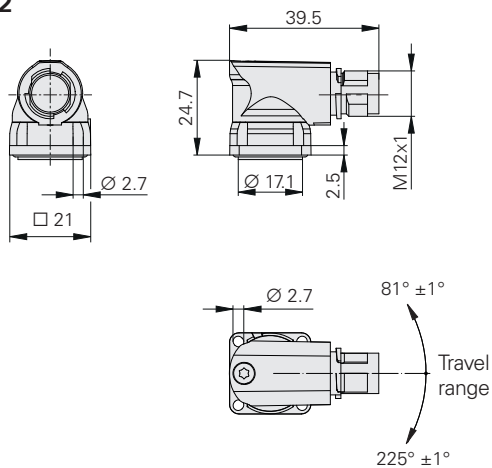

mm  
  
 Tolerancing ISO 8015  
 ISO 2768:1989 - m H  
 ≤ 6 mm: ±0.2 mm

**Required mating dimensions**

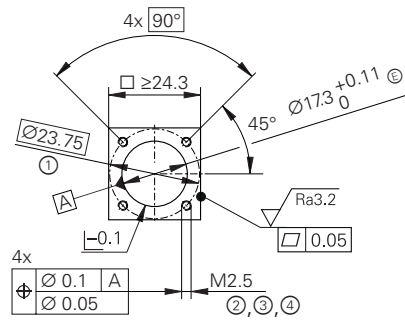

- 1 = Bolt circle diameter
- 2 = At least 3.5 mm of load-bearing thread
- 3 = Sealed blind hole or thread
- 4 = Tighten M2.5 screws with  $M_d = 0.45 \text{ Nm} \pm 0.05 \text{ Nm}$

**Connector**

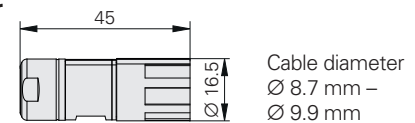

**Coupling**

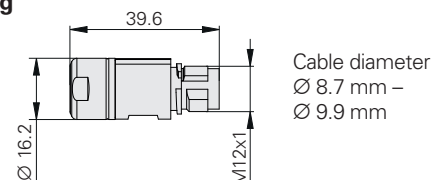

## HMC 6

### Flange socket

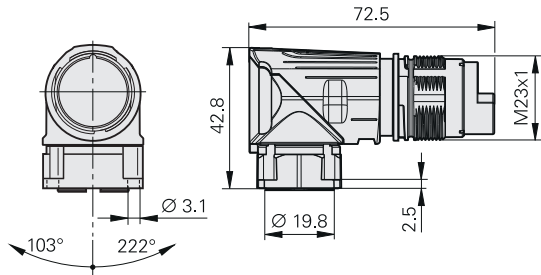

### Required mating dimensions for flange socket

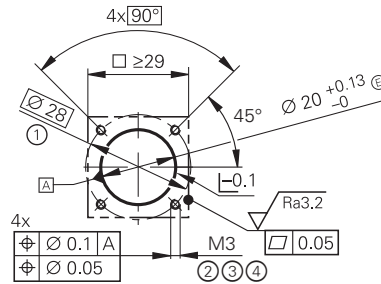

- 1 = Bolt circle diameter
- 2 = At least 3.5 mm of load-bearing thread
- 3 = Sealed blind hole or thread
- 4 = Tighten M3 screws with  $M_d = 0.8 \text{ Nm} \pm 0.05 \text{ Nm}$

### Connector

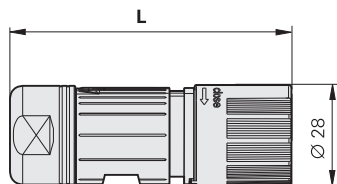

	L
Ø 9.5 mm – Ø 14.5 mm	78
Ø 14 mm – Ø 17 mm	80.5

### Coupling

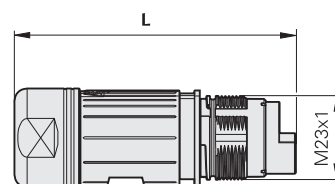

	L
Ø 9.5 mm – Ø 14.5 mm	78
Ø 14 mm – Ø 17 mm	80.5

## D-sub connector for HEIDENHAIN controls and downstream electronics

### Symbols

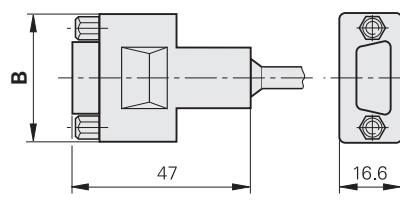
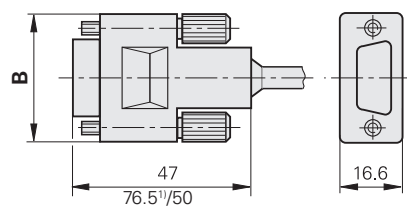

- 1) Interface electronics integrated into the connector
- 2) Design A, partially with integrated interface electronics

Number of pins	B
9	35
15	43
25	56

Male contacts



Female contacts



When engaged, the connections are **rated** at up to IP67 (D-sub connector: IP50; EN 60529). When not engaged, there is no protection.

### Accessories for flange sockets and M23 mounted couplings

**Threaded metal dust cap**  
ID 219926-01

**Gasket**  
ID 266526-01

mm



Tolerancing ISO 8015  
ISO 2768:1989 - m H  
≤ 6 mm: ±0.2 mm

# HMC 2 and HMC 6

## Single-cable solutions for servomotors

Servomotors normally require two separate pre-assembled cables:

- One encoder cable for the motor encoder
- One power cable for the motor supply

With the **HMC** solution (Hybrid Motor Cable), HEIDENHAIN has integrated the encoder cable into the power cable. Thus, only **one single cable** is now needed between the motor and the electrical cabinet.

The HMC 6 single-cable solution was specifically designed for the HEIDENHAIN **EnDat22** interface, and HMC 2 for **EnDat3**. With purely serial data transmission, cable lengths of up to 100 m can be realized. With HMC 6, all other encoders equipped with a purely serial RS-485 interface (e.g., SSI) can be connected as well. A wide range of encoders can therefore be used without the need for introducing a new interface.

The HMC solution combines the wires for the encoder, motor and brake into a single cable, which is connected to the motor via a special connector. For connection to the frequency inverter, the cable is split into power connections, brake connections and an encoder connection.

When the components are correctly assembled, the connecting elements attain an IP67 rating.

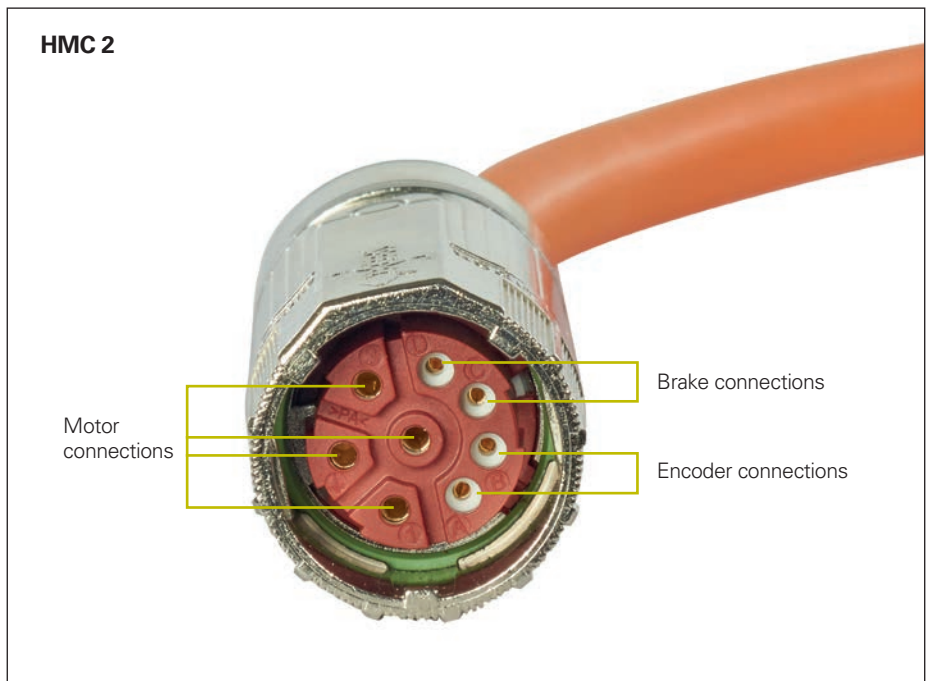
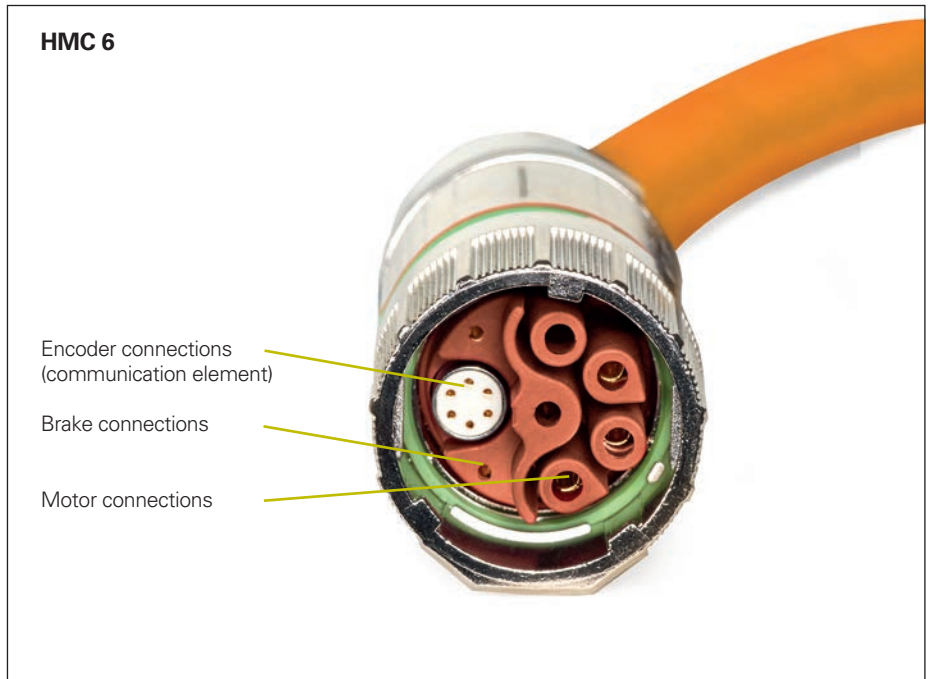

### Benefits

The HMC single-cable solutions offer a series of cost and quality benefits for motor and machine manufacturers:

- Continued use of existing interfaces
- Realization of smaller drag chains
- Significant improvement in drag-chain suitability thanks to fewer cables
- Wide range of available encoders for HMC 2 and HMC 6 transmission
- Eliminated separate assignment of power cables and encoder cables in the machine
- Reduced mechanical requirements (flange socket on the motor, cable ducts in the machine housing)
- Reduced logistics for cables and connectors
- Easier and faster installation
- Reduced documentation
- Fewer required servicing components
- Smaller motor profile with cable attached, enabling easier integration into the machine housing
- HEIDENHAIN-tested combination of power and encoder cable

The universal design of the HMC solution gives motor and machine manufacturers high flexibility, letting them use standard components on both the motor and the control.

**All HEIDENHAIN encoders with EnDat22 interface** or with purely serial data transfer without battery buffering as per RS-485 are suited for the HMC 6 single-cable solution. This includes motor encoders for servomotors in various sizes, linear and angle encoders used in direct drive motors, as well as encoders for **functional safety** up to SIL 3.

The HMC 2 single-cable solution can be used with **motor encoders featuring the EnDat 3 interface** (ordering designation: E30-R2) and purely serial data transmission via two wires. The ExI 1100/1300 and ExN 1300 series rotary encoders are available for functional safety applications with up to SIL 3.

For the controlling hardware you can continue to use already deployed frequency inverters or controller units. The HMC cables have been designed for easy assembly of the matching connecting elements. Importantly, this does not impair the noise immunity.

### Components

Preparing a motor for the single-cable solution requires only a handful of components.

### Connecting element on the motor

The motor housing is equipped with a standard flange socket for HMC 2 or a special angle flange socket for HMC 6. This angle flange socket brings together the wires for the encoder, motor power, and brake.

### Crimping tools for the power wires

The crimp contacts for the power and brake wires are assembled with the usual tools.

### Output cables inside the motor housing

The rotary encoder is connected by means of the output cables inside the motor housing: your pre-assembled communication element for the HMC 6 or the two contacts for HMC 2 are simply plugged into the angle flange socket.

### Cable with hybrid connector

The HMC connecting cable contains the wires for the encoder, power supply, and brake.

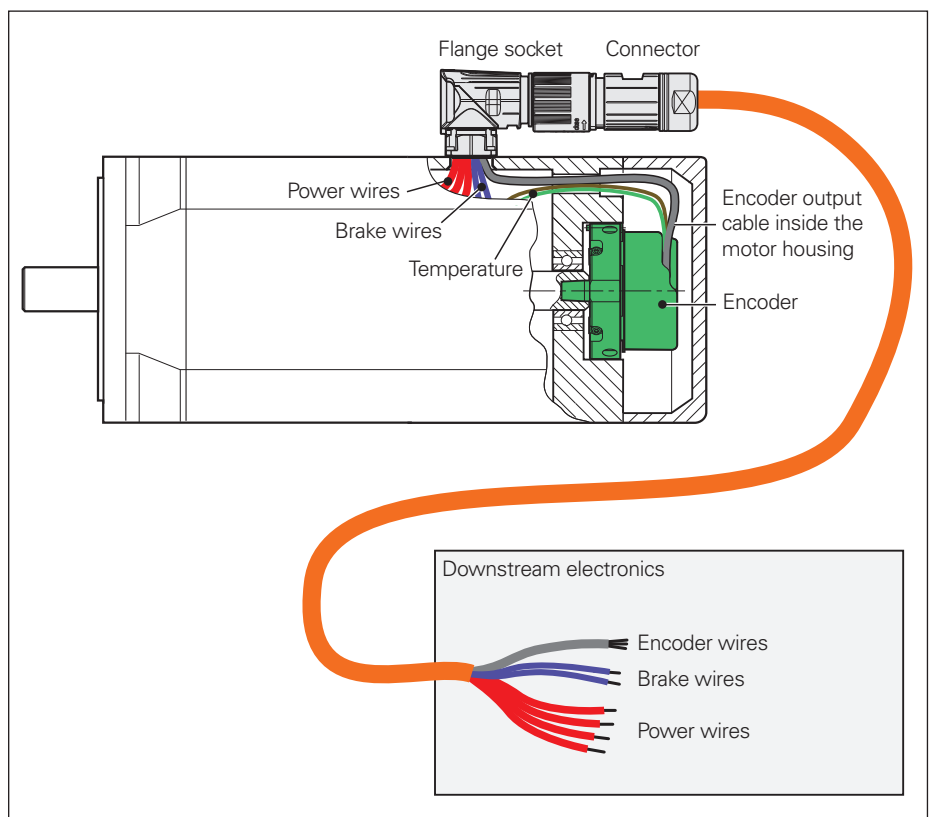

### Further information:

For more information about HMC 6 and HMC 2, refer to the respective Product Information document and visit [www.endat.de](http://www.endat.de).

# Cable overviews

## Example of a cable configuration

### Layout of the cable overviews

In the cable overviews, the devices and their pre-assembled cables to the downstream electronics are shown on the left. Various connecting elements or signal converters may be used between them.

The downstream electronics are shown on the right. They are grouped based on their pin layout and differentiated by their connecting element.

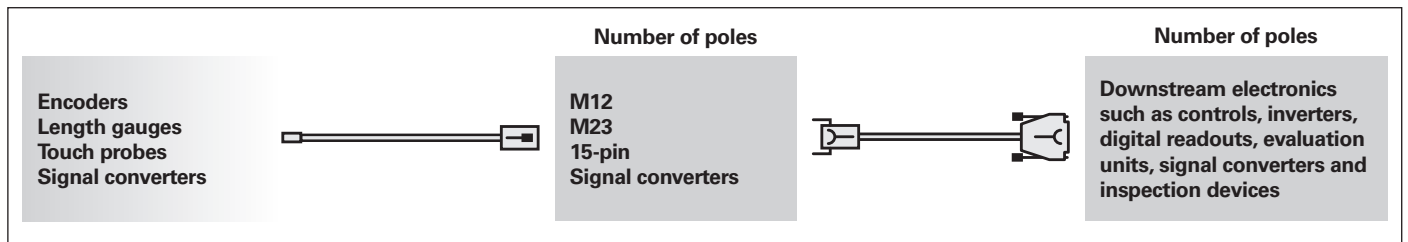

Schematic representation of cable overviews

### Example

Connection of an RCN with a TNC in a machine tool under the following circumstances:



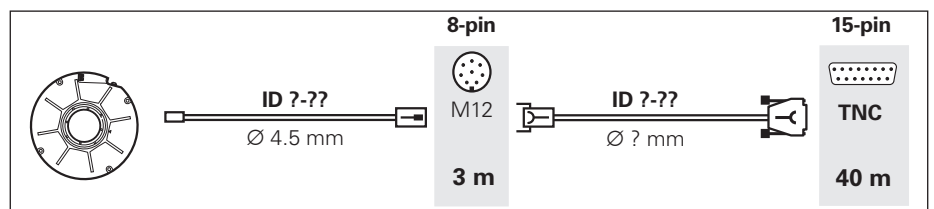



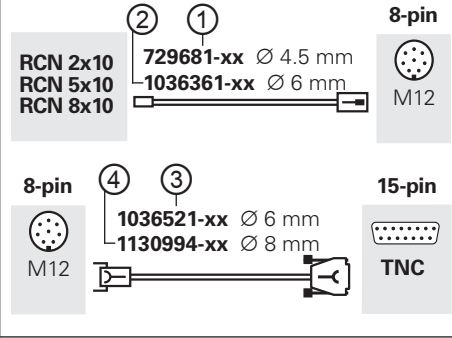
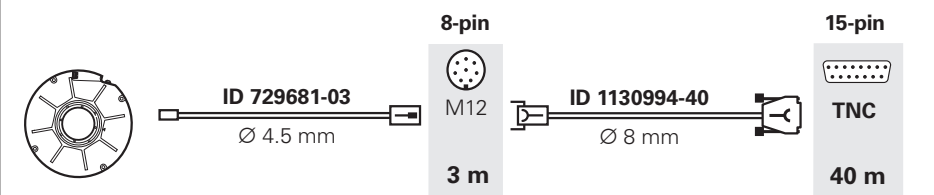









- RCN 5310:  
Interface: EnDat 2.2  
Ordering designation: EnDat22  
Extended supply voltage range:  
 $U_{Pmin} = 3.6 \text{ V}$  (power consumption:  
 $P_{Mmin} \leq 1100 \text{ mW}$ )  
 $U_{Pmax} = 14 \text{ V}$  (power consumption:  
 $P_{Mmax} \leq 1300 \text{ mW}$ )
- Adapter cable (APK) for the connection on the encoder:  
Cable length:  $L_{C1} = 3 \text{ m}$ ;  $\varnothing 4.5 \text{ mm}$
- M12 connecting element at the transition to the drag chain
- Adapter cable (APK) for the control:  
Cable length:  $L_{C2} = 40 \text{ m}$
- TNC 640:  
Encoder input: 15-pin D-sub  
Supply voltage:  $U_E \text{ min. } 4.9 \text{ V}$   
Sense lines are additionally used for the power supply

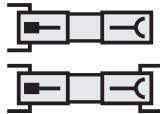

The following example illustrates the use of the cable overviews, cable list and pin layouts.

<p>Select the appropriate cable overview based on the desired interface and the ordering designation of the encoder.</p>	<p>Adapter cables and connecting cables: EnDat (EnDat22)</p>
<p>Determine the ID number of the cable (in some cases, multiple ID numbers are possible). Pay attention to the correct cable configuration, connecting element and number of poles!</p>	 <p>An APK with <math>\varnothing</math> 4.5 mm is needed, so the cable ① is selected</p> <p>Cables with <math>\varnothing</math> 6 mm and <math>\varnothing</math> 8 mm are possible, so cables ③ and ④ can be used</p>
<p>Determine the permissible cable length for signal transmission (see <i>Cable lengths</i>). Observe the restrictions regarding the adapter cable for connection to the encoder!</p>	<p>EnDat 2.2 interface:          3 m APK <math>\varnothing</math> 4.5 mm on the RCN <math>\leq</math> 20 m <math>\checkmark</math>          43 m overall length <math>\leq</math> 100 m <math>\checkmark</math></p>
<p>To calculate the voltage drop, look up the cross section of the supply wires in the cable list.</p>	<p>729681-xx and 1036521-xx: <math>A_P = 2 \times 0.16 \text{ mm}^2</math>          1130994-xx: <math>A_P = 2 \times 0.35 \text{ mm}^2</math></p>
<p>Check for compliance with the supply voltage (see <i>Cable lengths</i>). Each combination of cables must be calculated separately.</p>	<p>The maximum permissible voltage drop is calculated based on the information regarding the encoder and control:  <math>\Delta U_{\max} = U_E - U_P = 4.9 \text{ V} - 3.6 \text{ V} = 1.3 \text{ V}</math></p>
<p>Calculate the resistance of the supply wires</p> $R_L = 2 \frac{1.05 \cdot L_C}{56 \cdot A_P}$ <p>Add together the total resistance of both cables</p>	<p>① <math>R_L = 0.402 \ \Omega</math>          ③ <math>R_L = 4.69 \ \Omega</math>          ④ <math>R_L = 2.14 \ \Omega</math></p> <p>Total resistance          ①/③ <math>R_L = 5.0 \ \Omega</math>          ①/④ <math>R_L = 2.5 \ \Omega</math></p>
<p>Calculate the coefficients for determining the voltage drop</p> $b = R_L \frac{P_{M\max} - P_{M\min}}{U_{P\max} - U_{P\min}} + U_E$ $c = P_{M\min} \cdot R_L + \frac{P_{M\max} - P_{M\min}}{U_{P\max} - U_{P\min}} \cdot R_L \cdot (U_E - U_{P\min})$	<p>①/③ <math>b = 5.0</math>          ①/④ <math>b = 4.9</math></p> <p>①/③ <math>c = 5.6</math>          ①/④ <math>c = 2.8</math></p>
<p>Calculate the voltage drop based on the coefficients b and c, and compare with <math>\Delta U_{\max}</math></p> $\Delta U = 0.5 \cdot (b - \sqrt{b^2 - 4 \cdot c})$	<p>①/③ <math>\Delta U = 0.5 \cdot [5.0 - \sqrt{5.0^2 - 4 \cdot 5.6}]</math>  <math>\Delta U = 1.7 \text{ V} \times</math> (value too high)</p> <p>①/④ <math>\Delta U = 0.5 \cdot [4.9 - \sqrt{4.9^2 - 4 \cdot 2.8}]</math>  <math>\Delta U = 0.7 \text{ V} \checkmark</math></p>
<p>Determined cable configuration</p>	 <p>8-pin M12 3 m          15-pin TNC 40 m</p>

# Symbols in the cable overviews

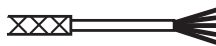
	Connector (male/female)		D-sub connector (male/female)
	Coupling (male/female)		D-sub connector with locking screws (male/female)
	Mounted coupling with flange (male/female)		D-sub connector (male) (interface electronics integrated into the connector)
	Flange socket (male/female)		Mini Delta Ribbon connector (male/female) MUF connector (male/female)
	Angle flange socket (male)		RJ45 connector
	Adapter connector (male/female)		Push-pull connector
	PUR cable		Push-pull flange socket
	PUR cable in protective sleeve		
	Cable with braided shield		
	PUR cable in protective sleeve and steel wire sheathing		

# Adapter cables and connecting cables: EnDat (EnDat22)

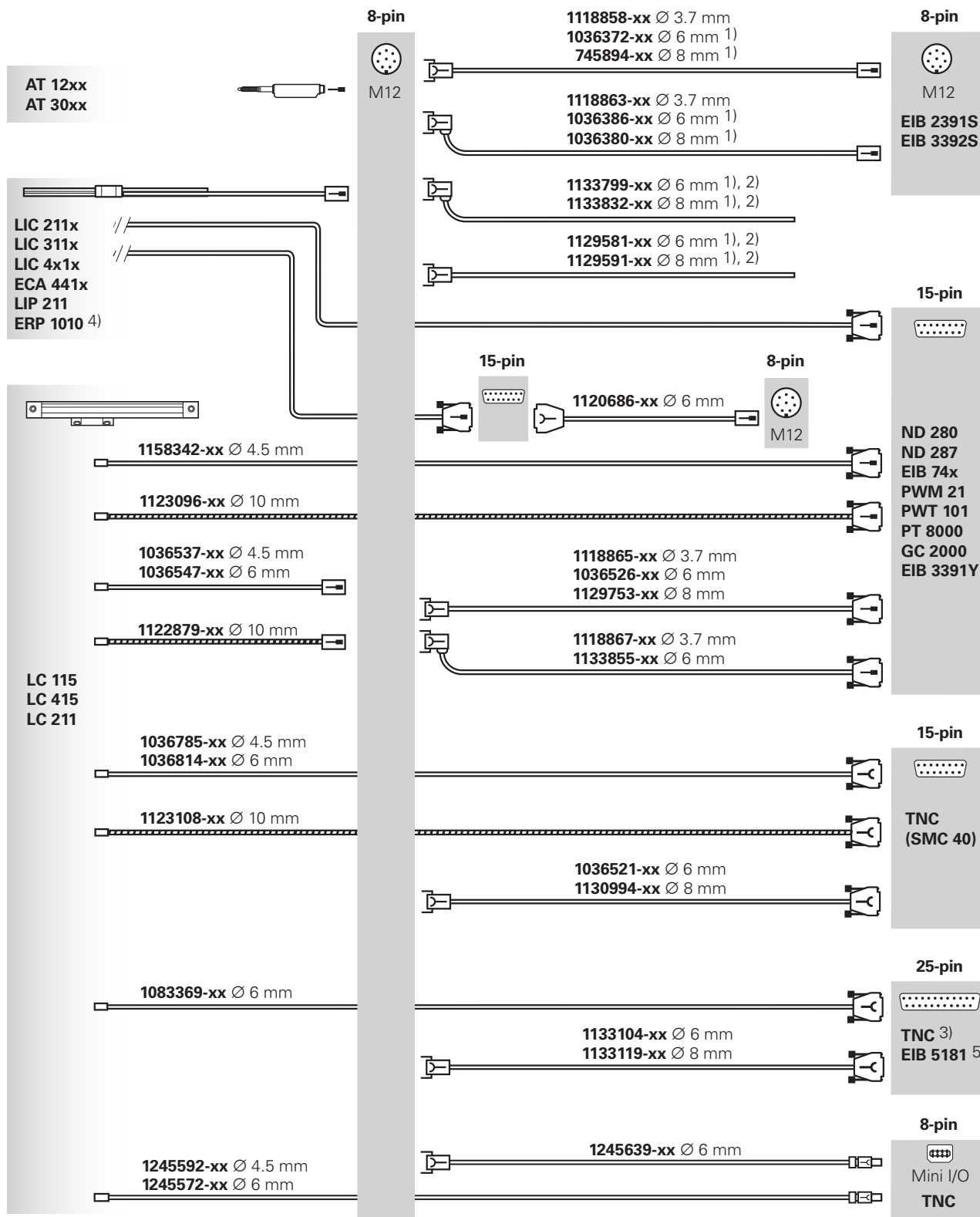

<sup>1)</sup> Also suitable for Fanuc / Mitsubishi / Panasonic / Yaskawa

<sup>2)</sup> Comply with *Electromagnetic compatibility* in the *General electrical information*

<sup>3)</sup> Optional: KTY/PT1000 adapter for the TNC; adapter for U<sub>P</sub>=12 V for TNC (only Gen 3!)

<sup>4)</sup> Connection of variant with SHR-12V-S connecting element to PWM 21 via adapter connector (ID 1234385-01)

<sup>5)</sup> To TNC with connecting cable (ID 1286965-xx)

# Adapter cables and connecting cables: EnDat (EnDat22)

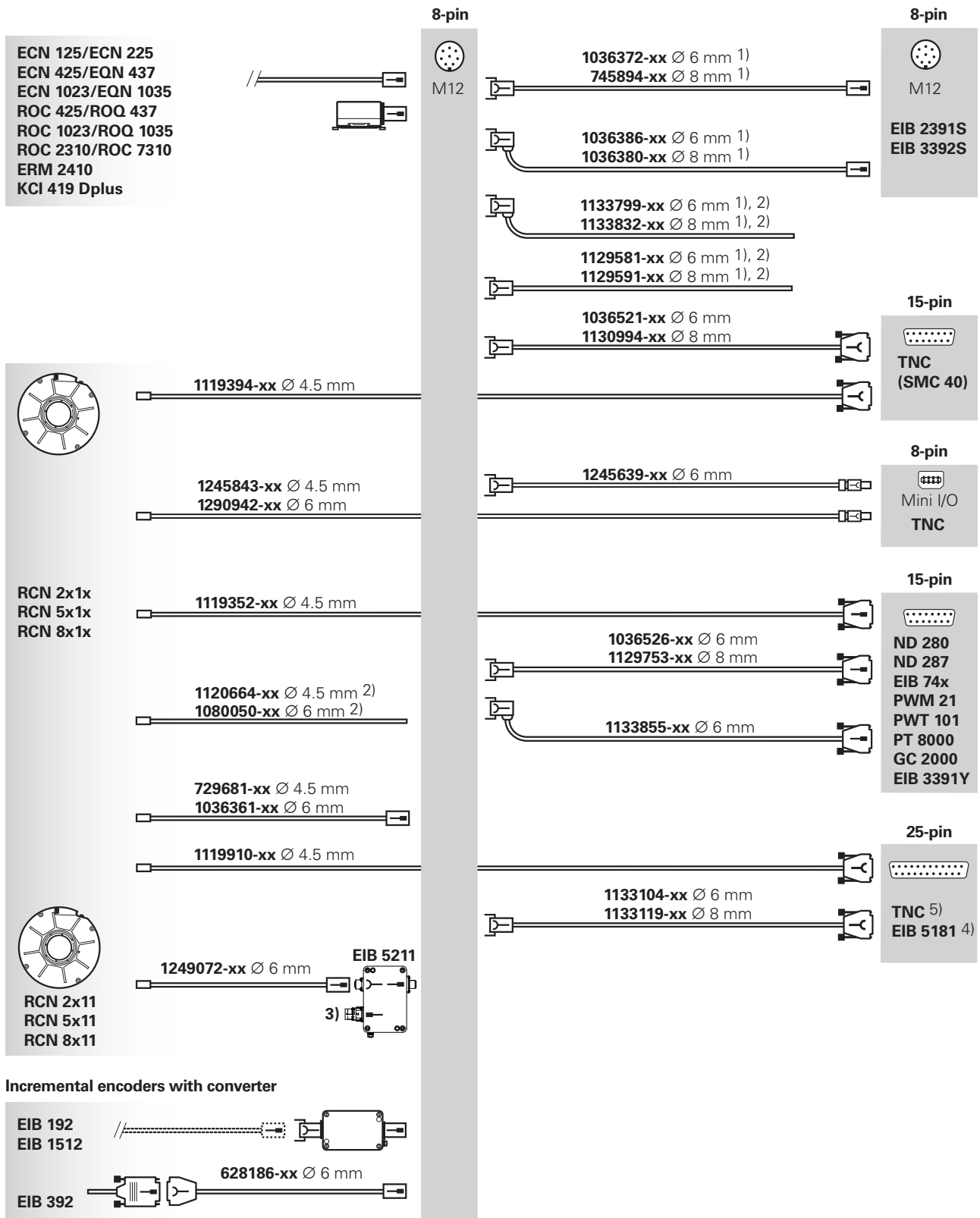

1) Also suitable for Fanuc / Mitsubishi / Panasonic / Yaskawa  
 2) Comply with *Electromagnetic compatibility* in the general electrical information  
 3) Mating connector (ID 1268541-01)  
 4) To TNC with connecting cable (ID 1286965-xx)  
 5) Optional: KTY/PT1000 adapter for TNC; adapter for  $U_p=12\text{ V}$  for TNC (only Gen 3!)

# Adapter cables and connecting cables: DRIVE-CLiQ

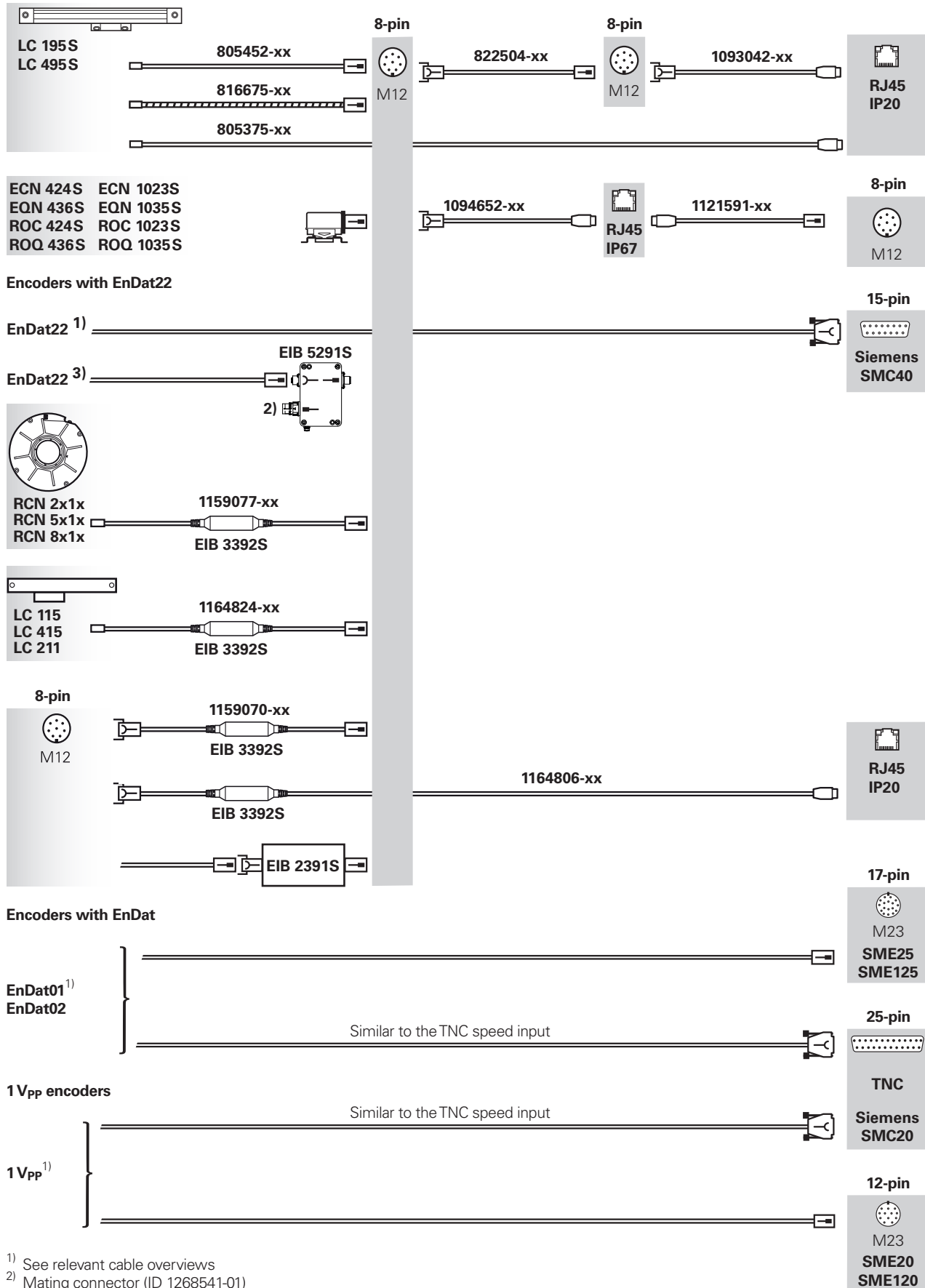

<sup>1)</sup> See relevant cable overviews  
<sup>2)</sup> Mating connector (ID 1268541-01)  
<sup>3)</sup> For pre-assembled cable, see EIB 5211

# Adapter cables and connecting cables: Fanuc Serial Interface

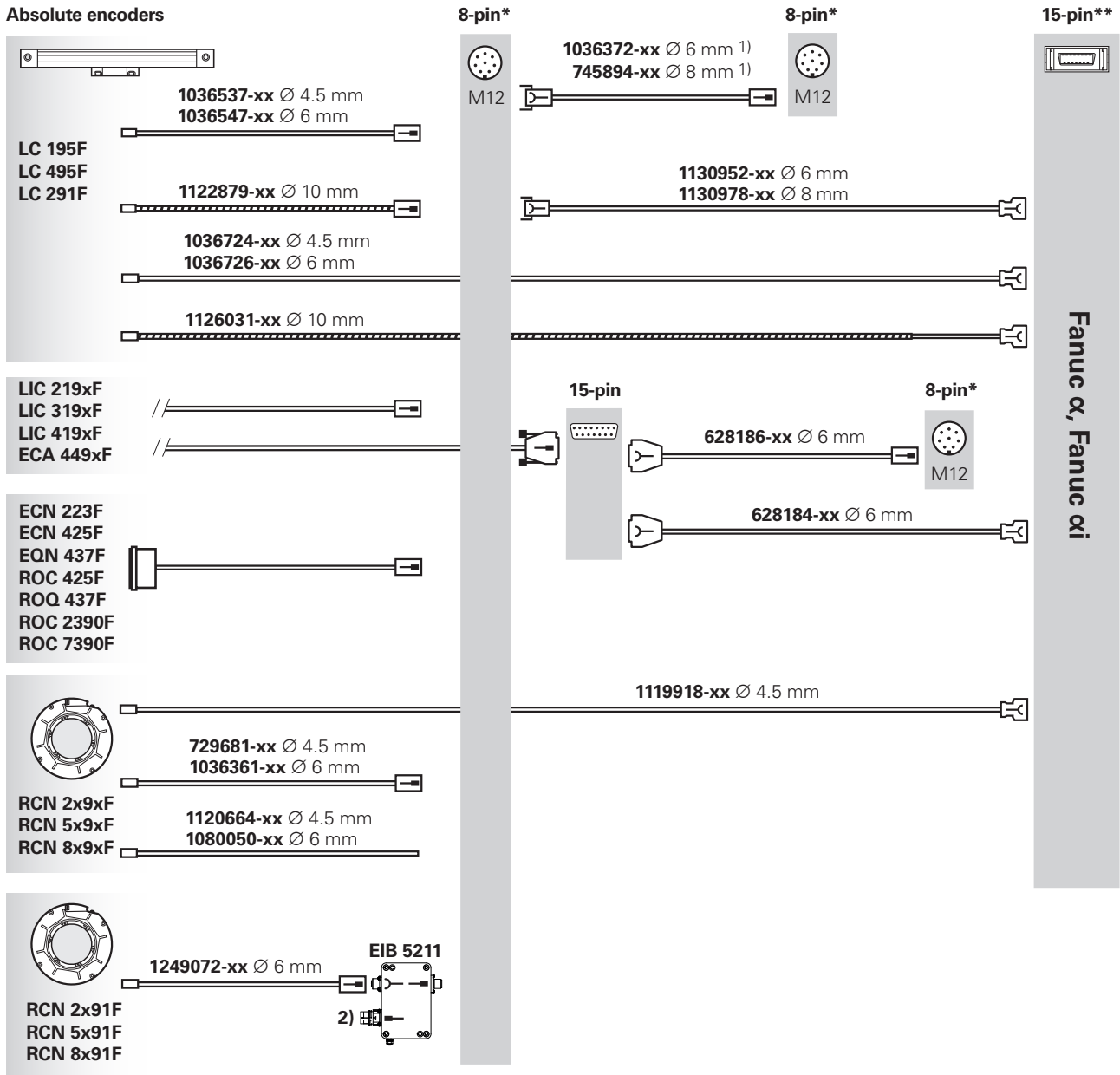

1) For other M12 connecting cables, see EnDat (EnDat22)  
 2) Mating connector (ID 1268541-01)  
 \* Recommended for new applications  
 \*\* 20-pin connector housing with 15-pin insert

# Adapter cables and connecting cables: Fanuc Serial Interface

## Absolute encoders

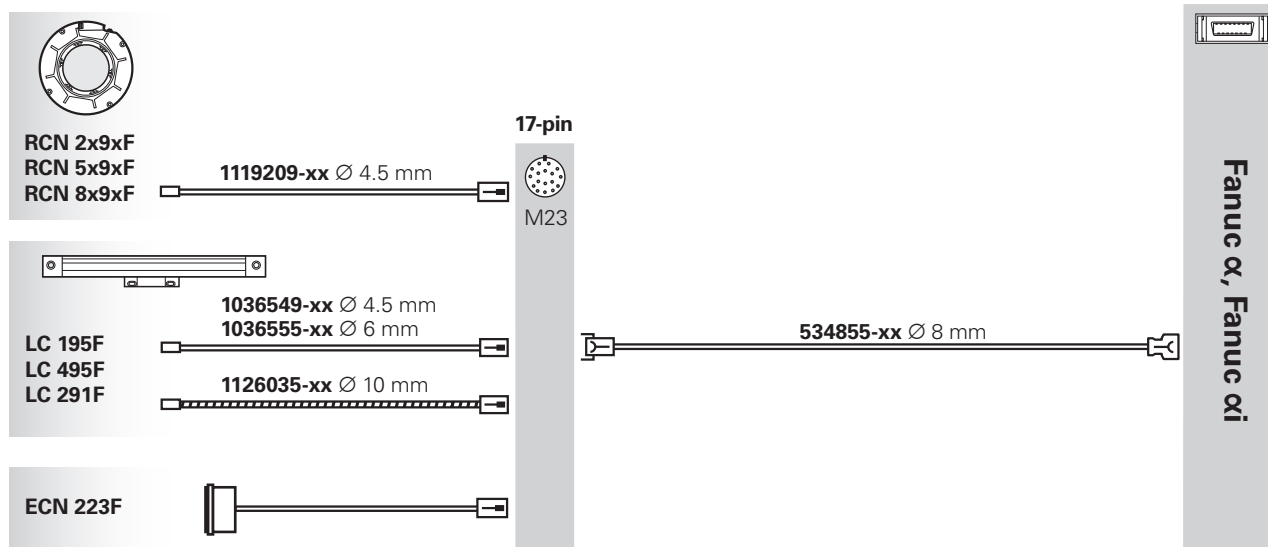

## Incremental encoders with converter

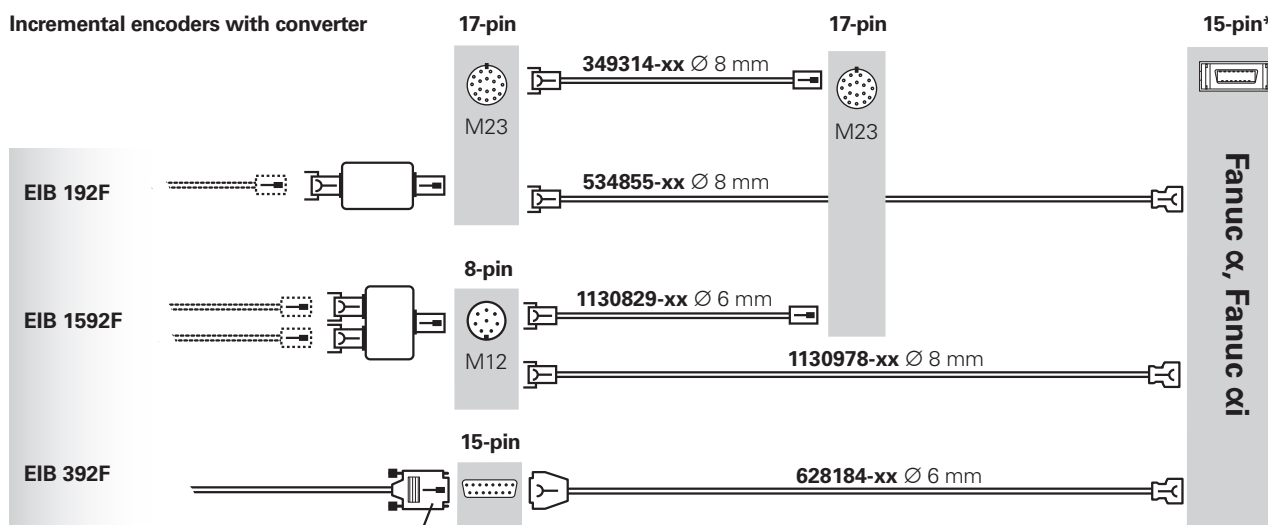

D-sub connector (male), with interface electronics integrated into the connector

## Incremental encoders with TTL

For adapter cables, see the cable overview for TTL signal cables

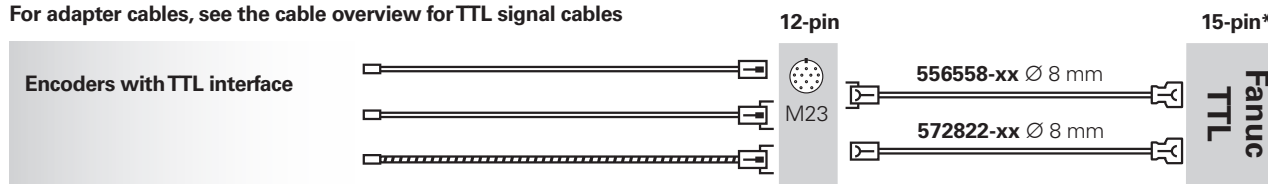

**Caution: Always test the compatibility of the TTL interface between the encoder and Fanuc on an individual basis!**

\* 20-pin connector housing with 15-pin insert

# Adapter cables and connecting cables: Mitsubishi high speed interface

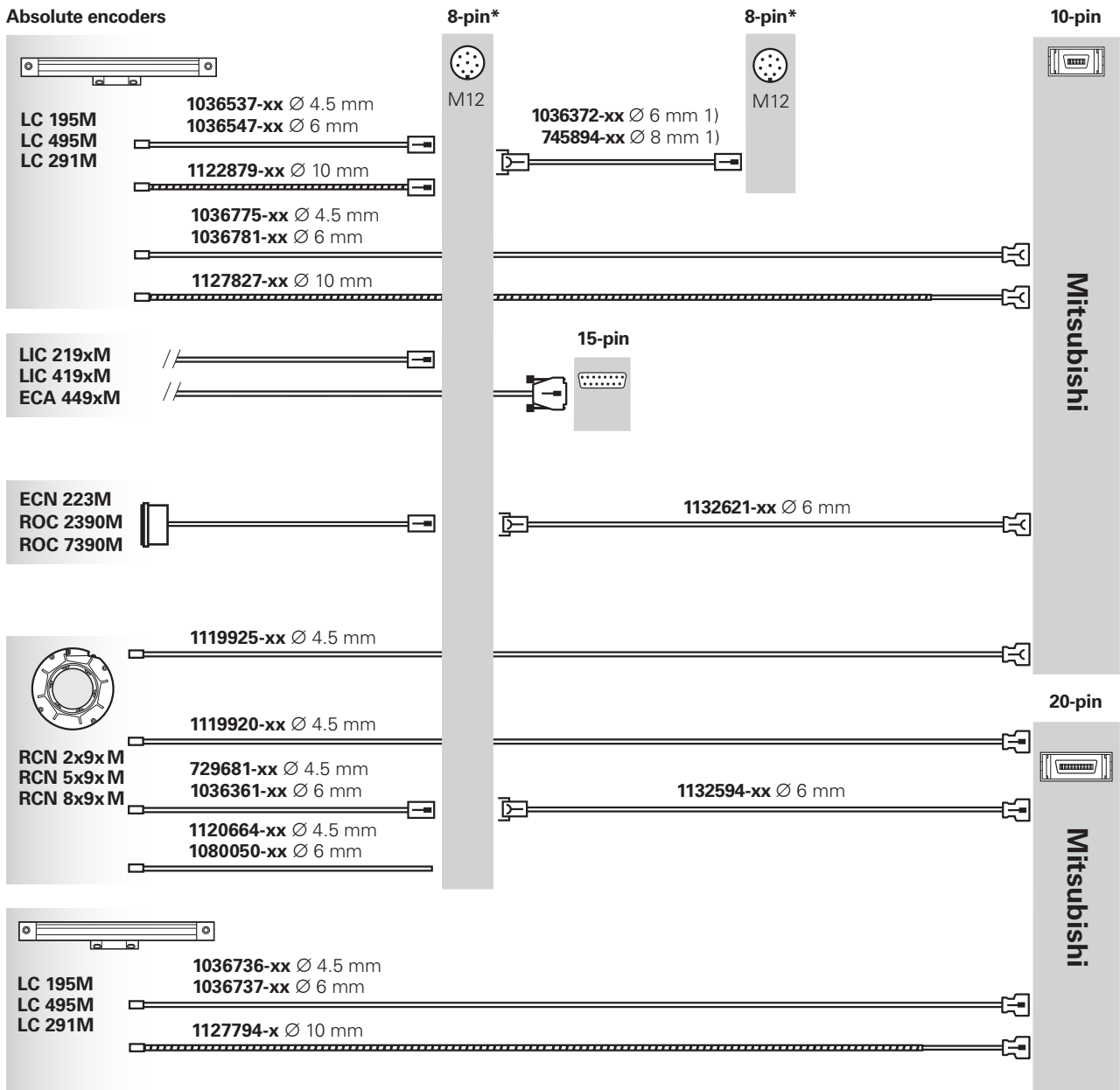

1) For other M12 connecting cables, see EnDat (EnDat22)

\* Recommended for new applications

# Adapter cables and connecting cables: Mitsubishi high speed interface

## Absolute encoders

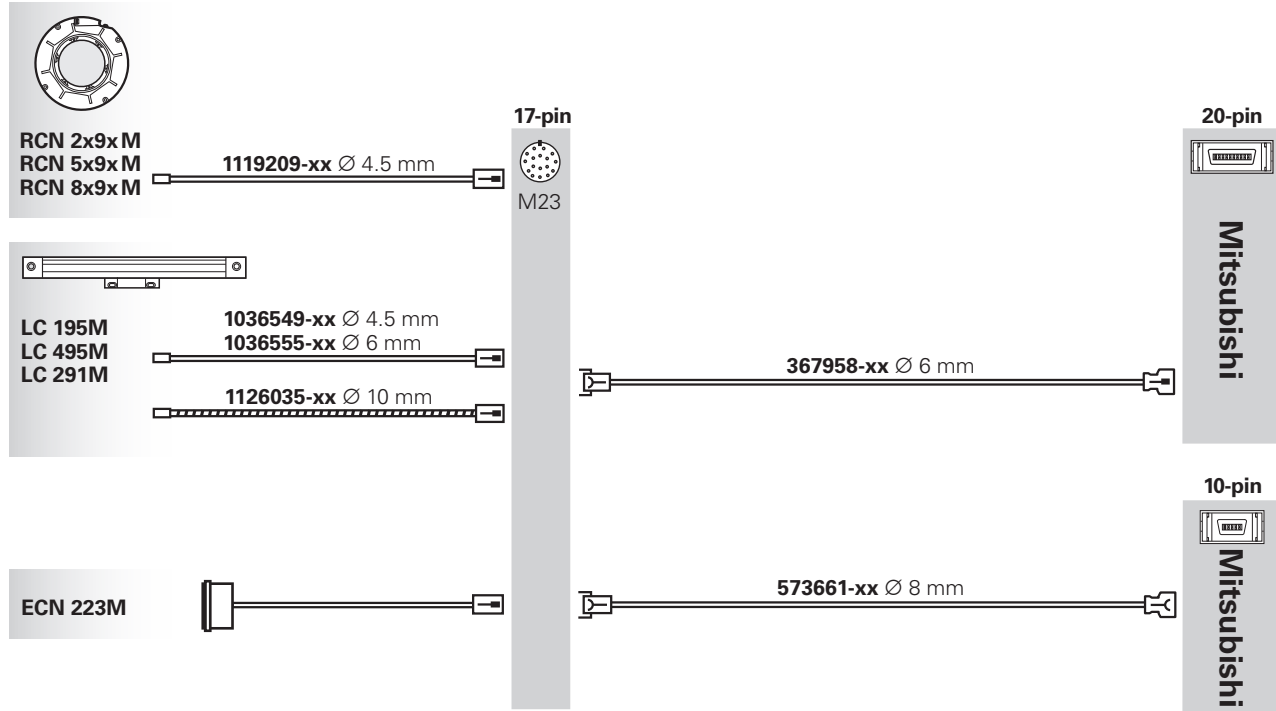

## Incremental encoders with converter

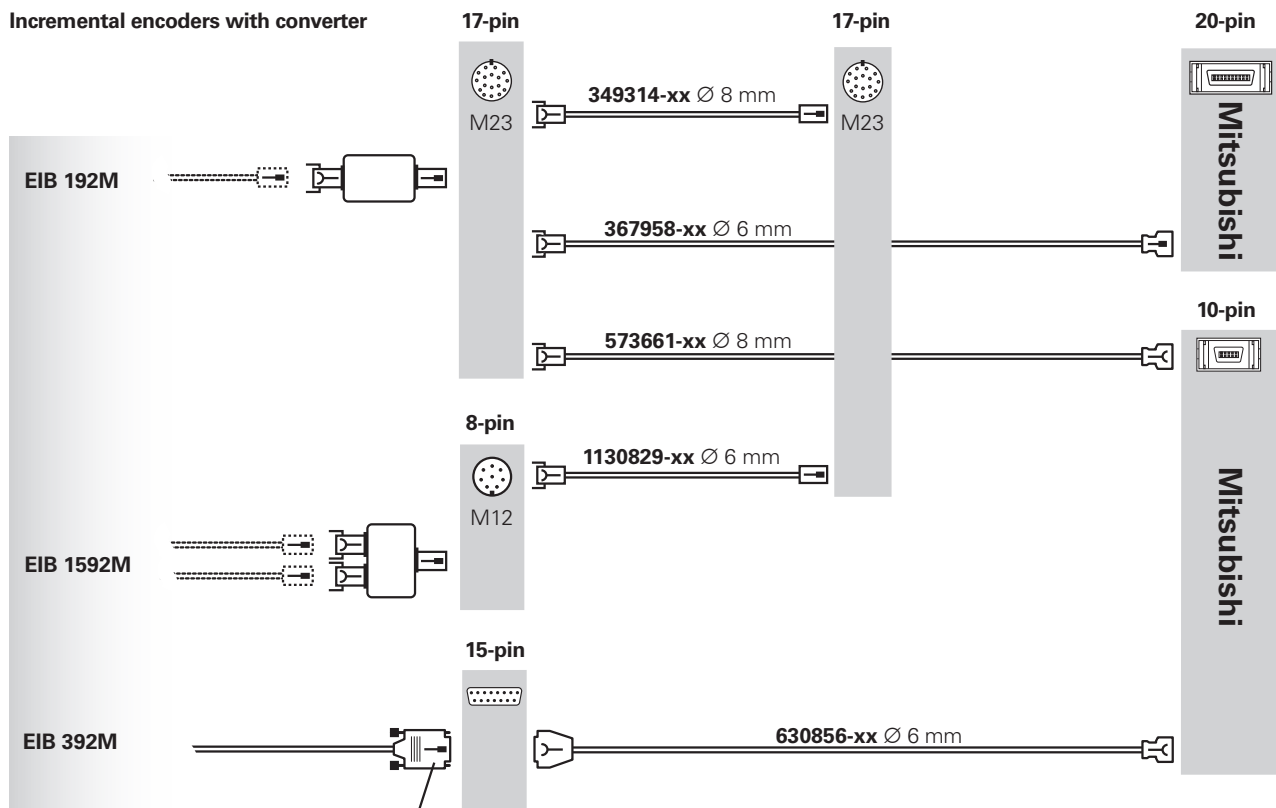

D-sub connector (male), with interface electronics integrated into the connector

<sup>1)</sup> For other M12 connecting cables, see EnDat (EnDat22)

# Adapter cables and connecting cables: Panasonic Serial Interface

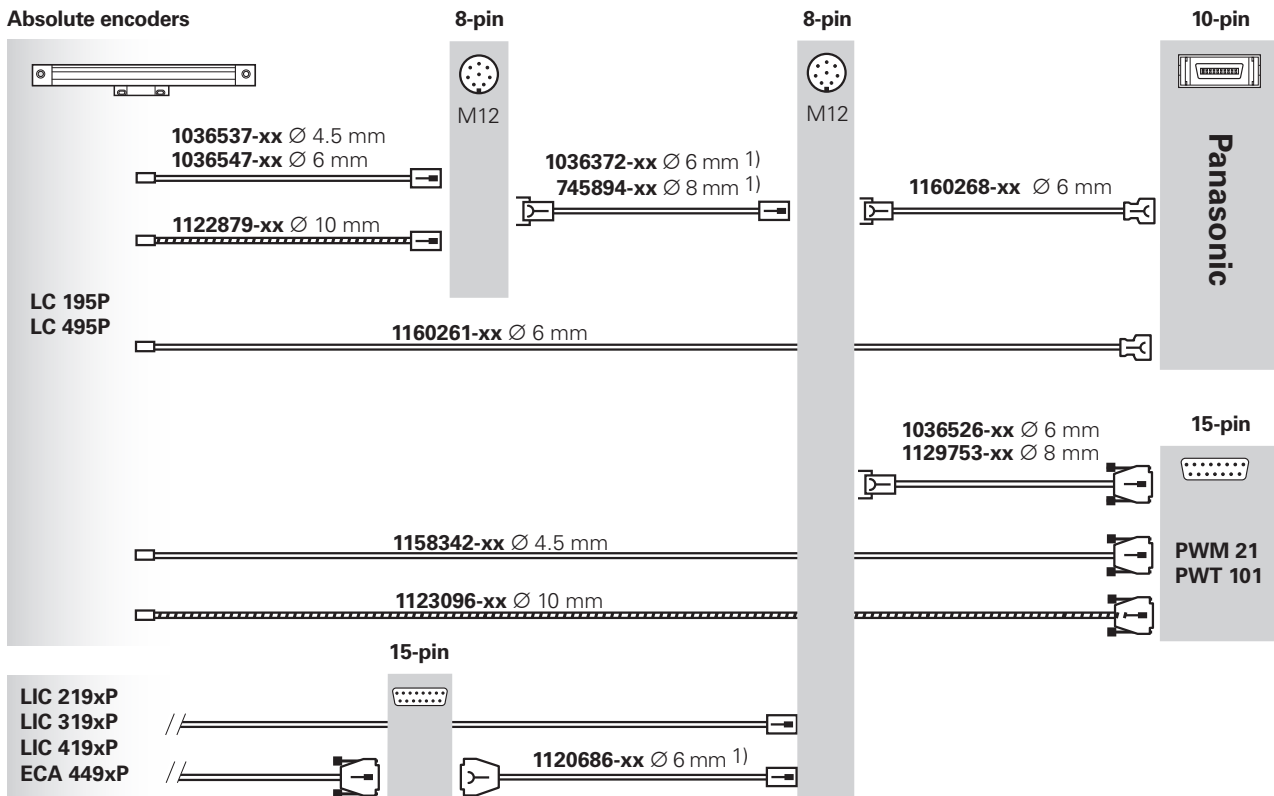

<sup>1)</sup> For other M12 connecting cables, see EnDat (EnDat22)

# Adapter cables and connecting cables: Yaskawa Serial Interface

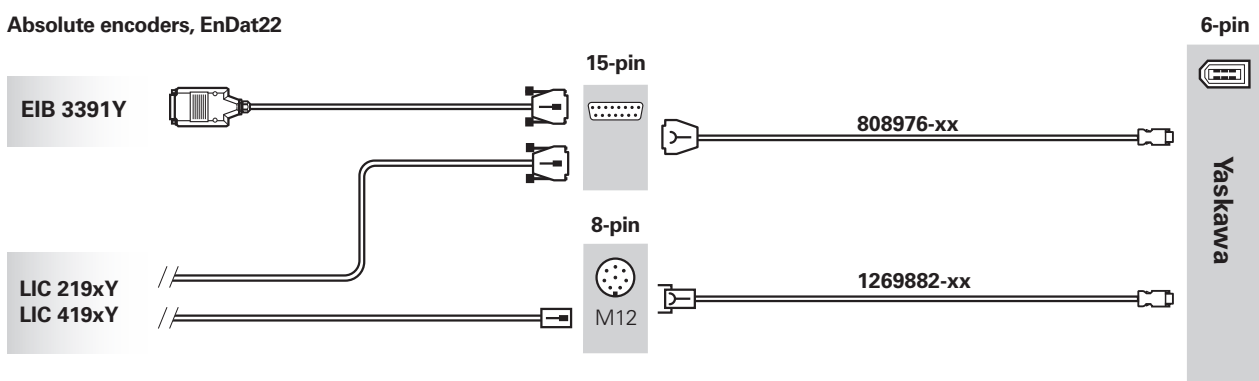

# Adapter cables and connecting cables: EnDat interface (EnDat0x) or SSI interface

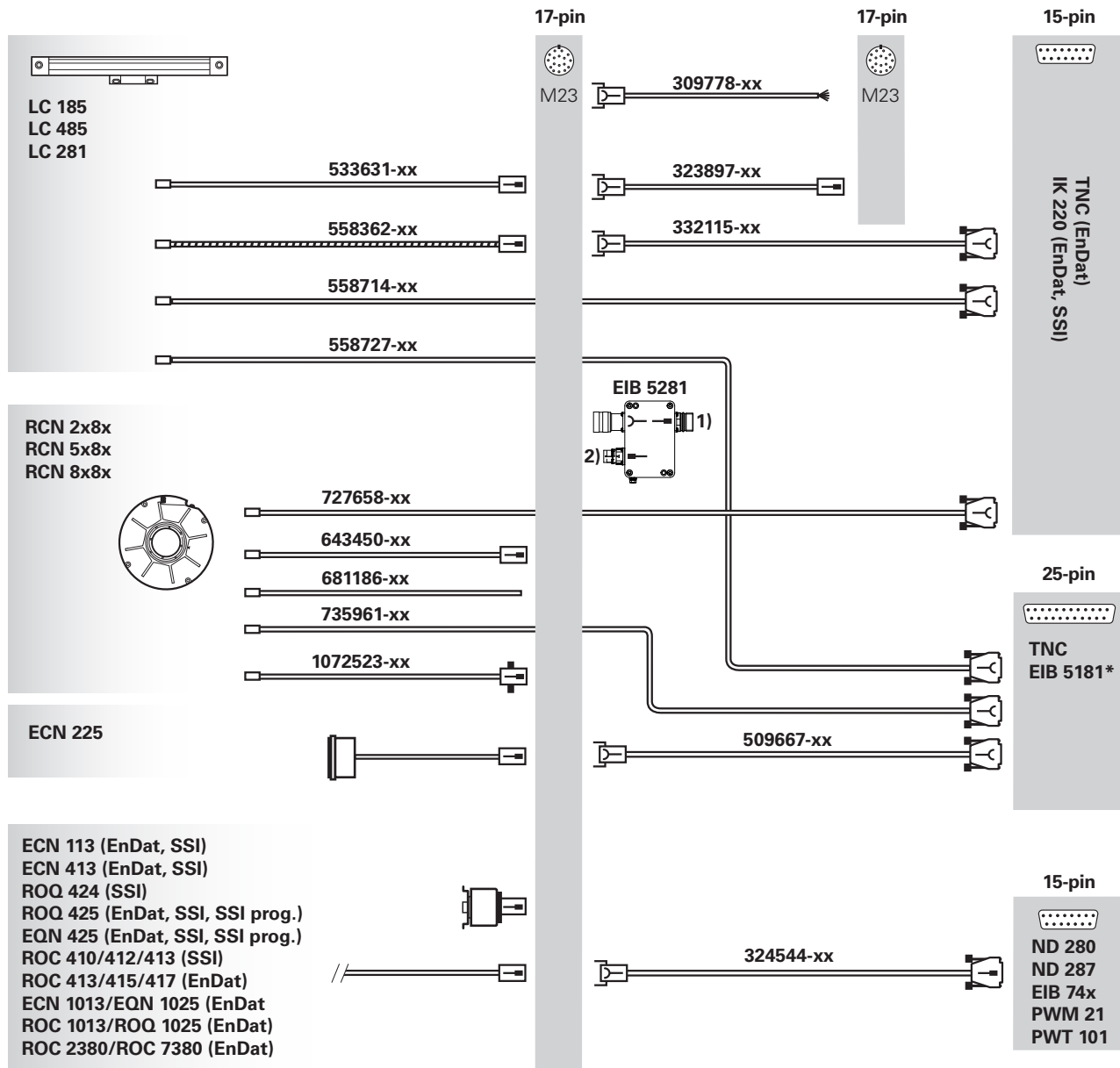

<sup>1)</sup> The output of the EIB 5281 for the connection to the TNC has a different pin layout and must not be connected with the cables shown on this page.  
For suitable cables, see the cable overviews in the TNC brochure *Information for the Machine Tool Builder*.

<sup>2)</sup> Mating connector (ID 1268541-01)

\* To TNC with connecting cable (ID 1286965-xx)

# Adapter cables and connecting cables: 1 V<sub>PP</sub>

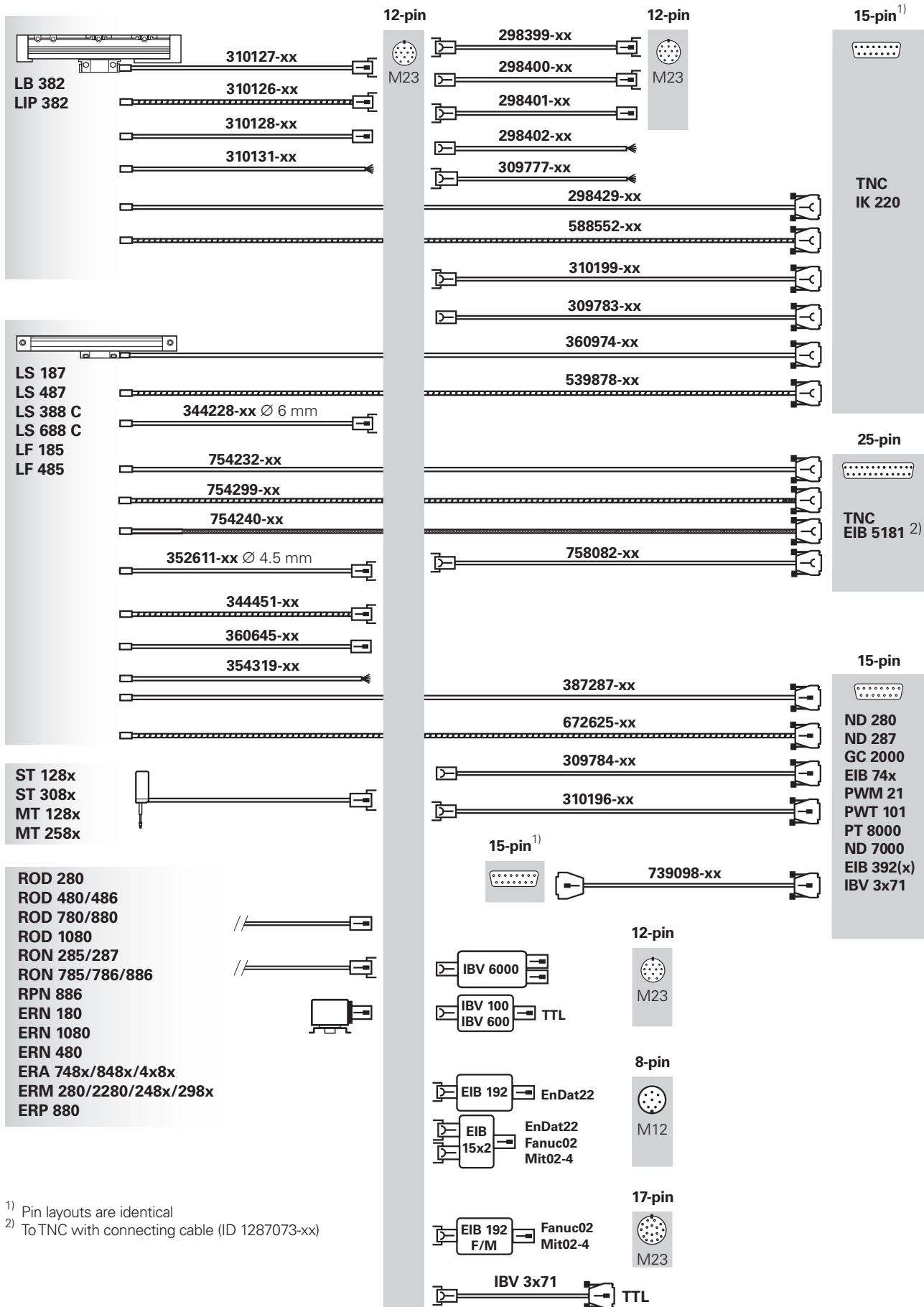

<sup>1)</sup> Pin layouts are identical  
<sup>2)</sup> To TNC with connecting cable (ID 1287073-xx)

# Adapter cables and connecting cables: 1 V<sub>PP</sub>

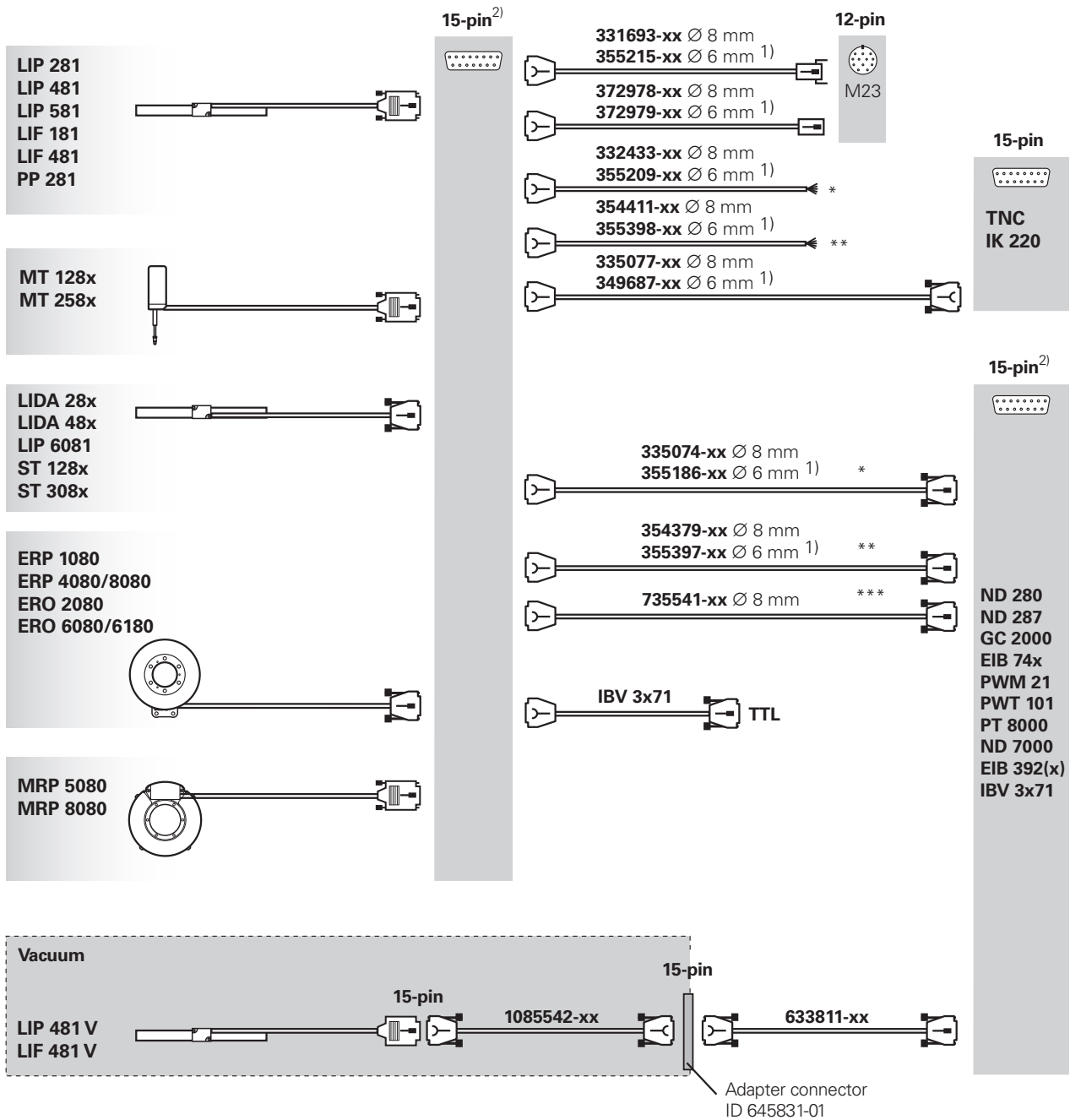

- \* Without limit/homing signals
- \*\* With limit/homing signals
- \*\*\* With programming line for mounting the LIP 281
- <sup>1)</sup> Cable length ≤ 9 m
- <sup>2)</sup> Pin layouts are identical

# Adapter cables and connecting cables: TTL or HTL

## TTL

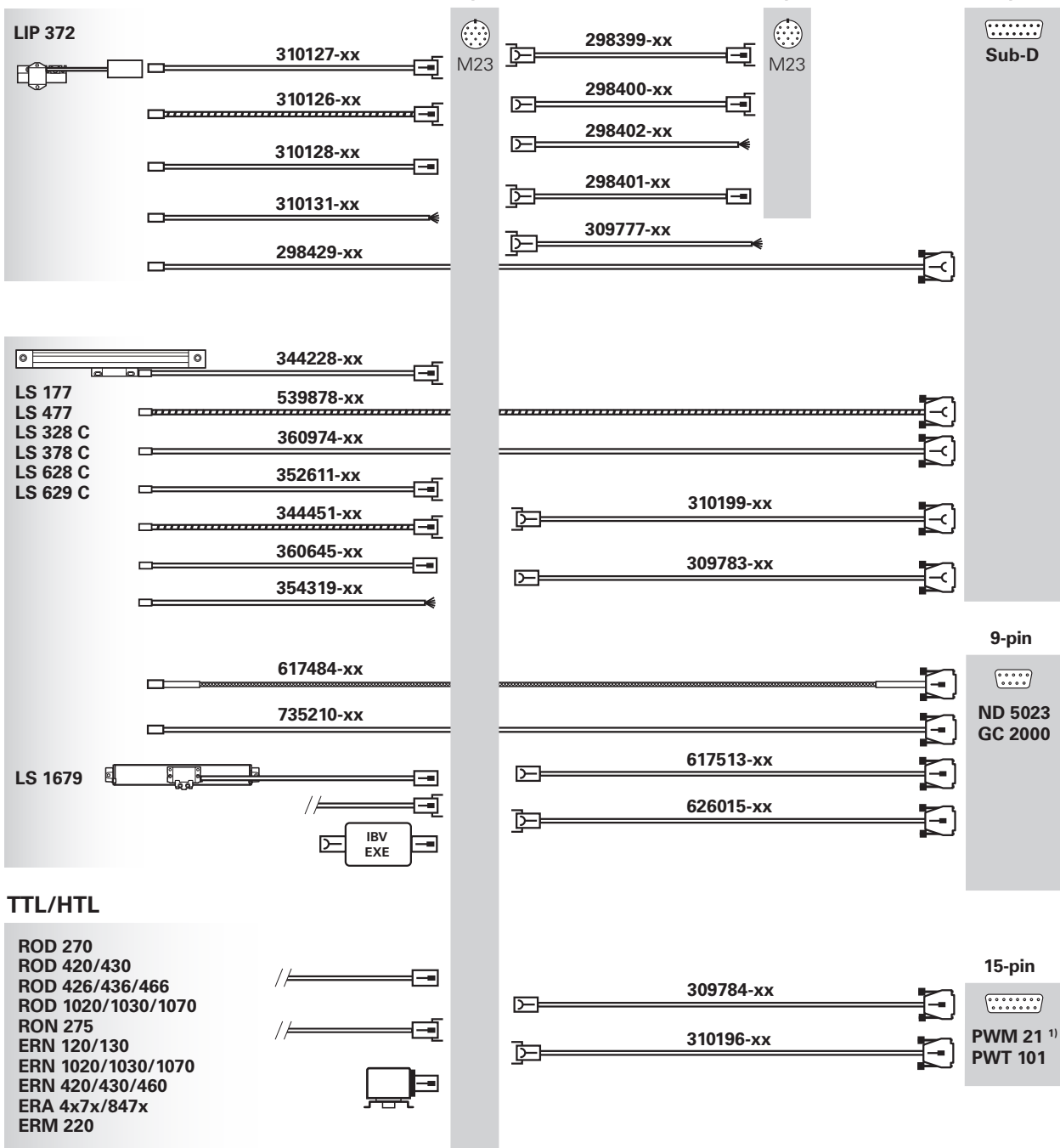

<sup>1)</sup> Signal adapter needed for HTL

# Adapter cables and connecting cables: TTL or HTL

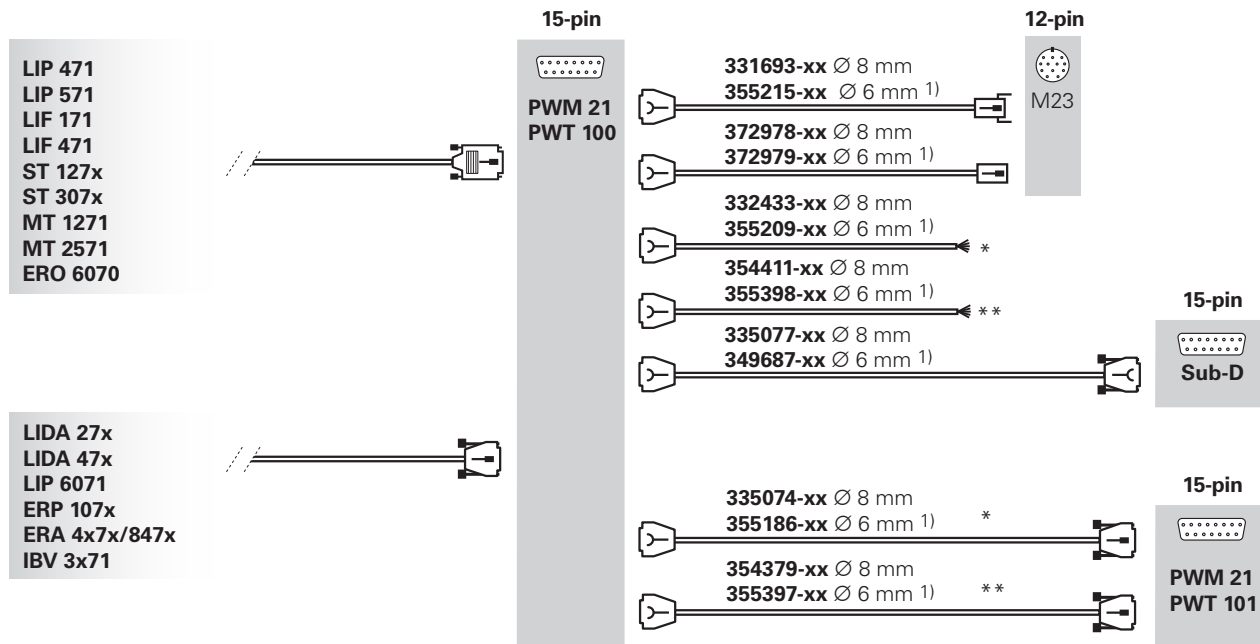

\* Without limit/homing signals  
 \*\* With limit/homing signals  
 1) Cable length ≤ 9 m

# Adapter cables and connecting cables: 11 $\mu$ A<sub>PP</sub>

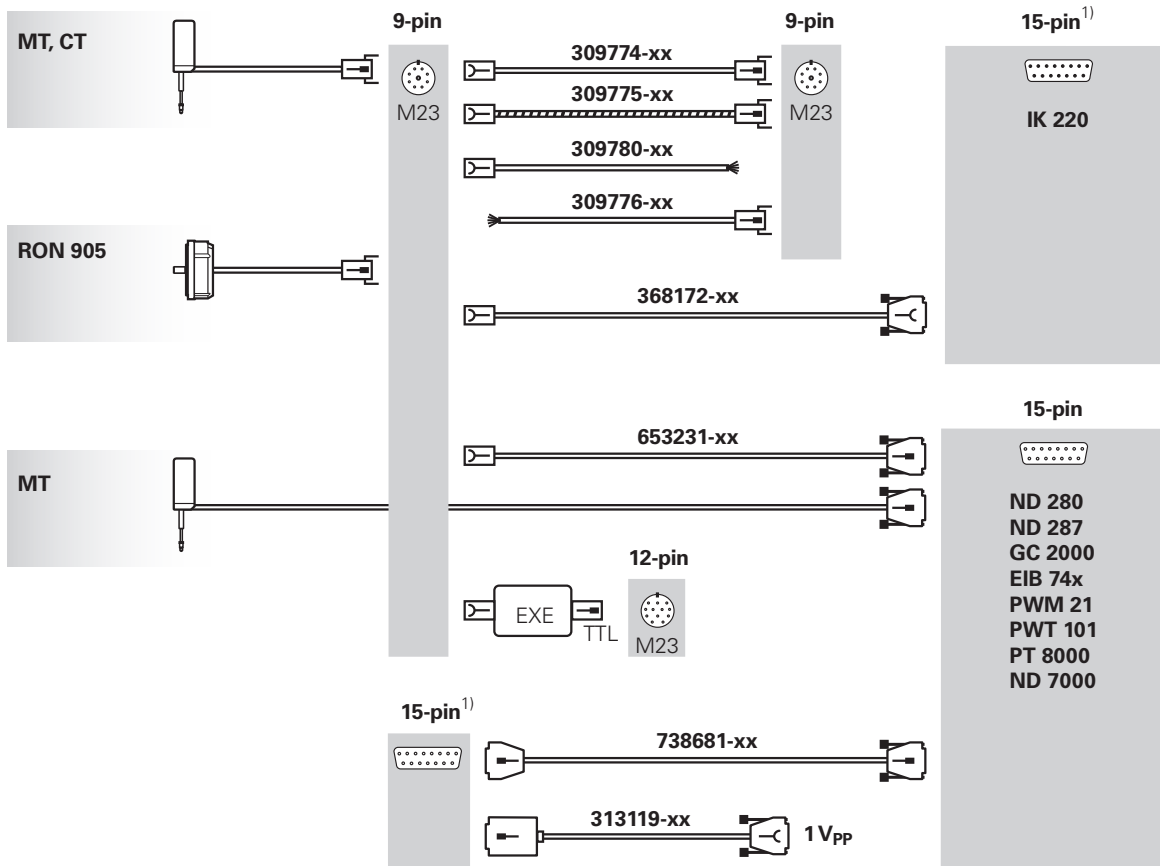

<sup>1)</sup> Pin layouts are identical

# Adapter cables and connecting cables: touch probes with EnDat or HTL

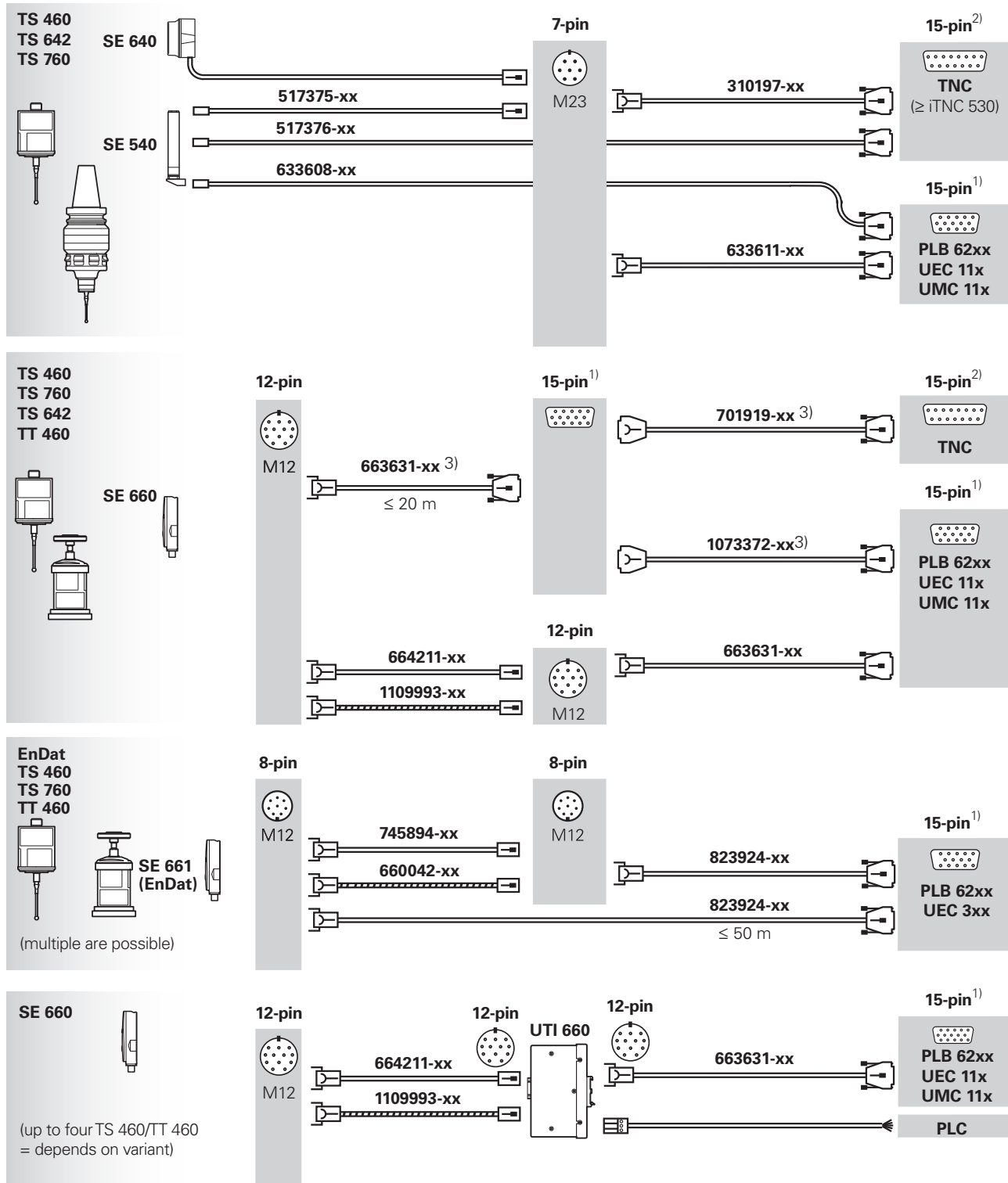

<sup>1), 2)</sup> Pin layouts are identical

<sup>3)</sup> If overall length is over 20 m: ID 663631-xx max. 10 m; the rest with ID 701919-xx/1073372-xx

# Adapter cables and connecting cables: touch probes

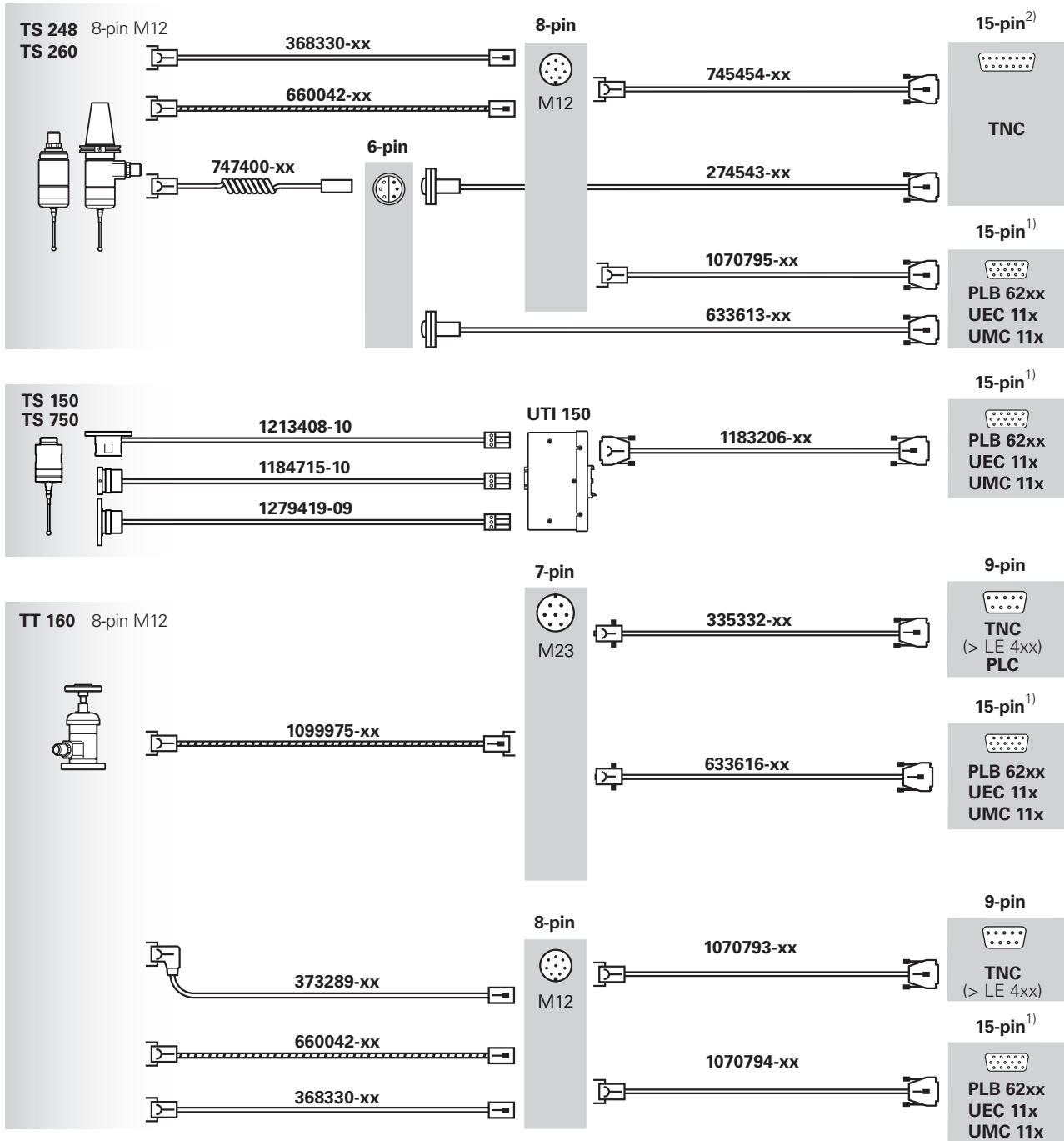



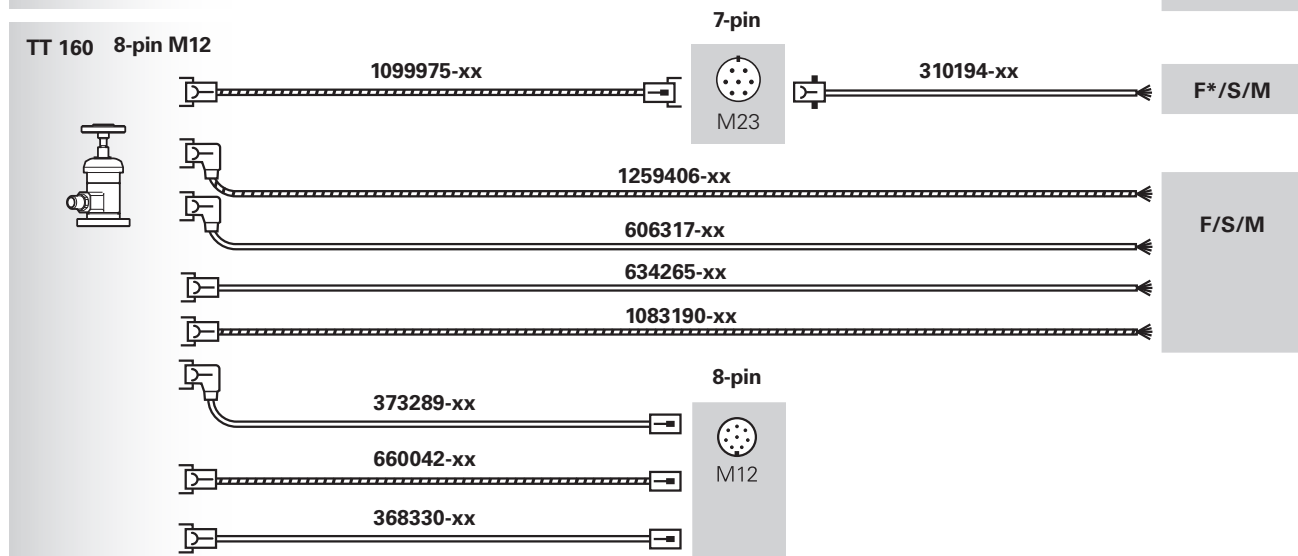
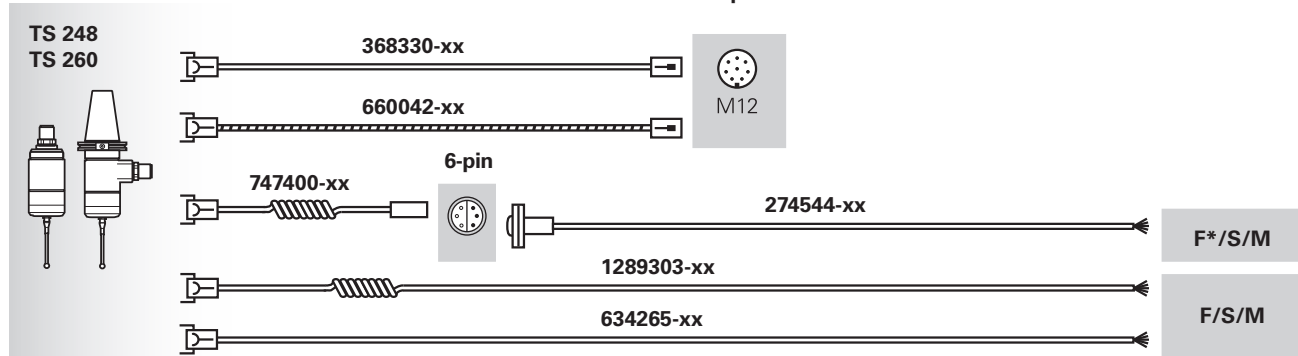
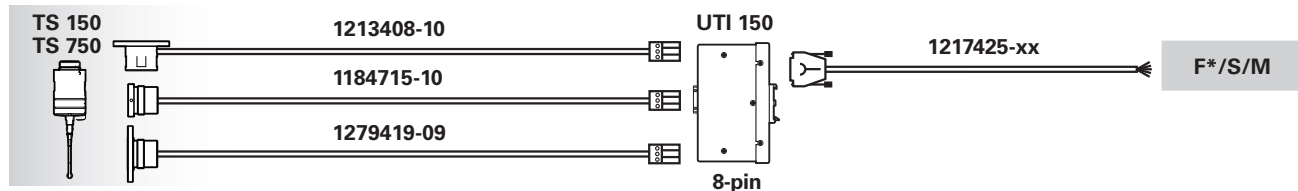
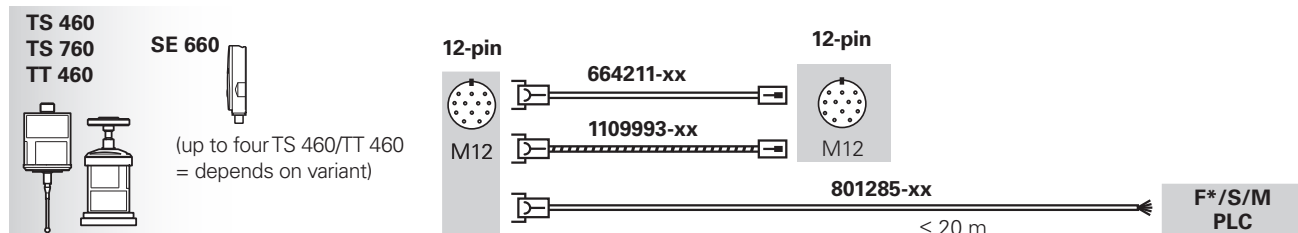
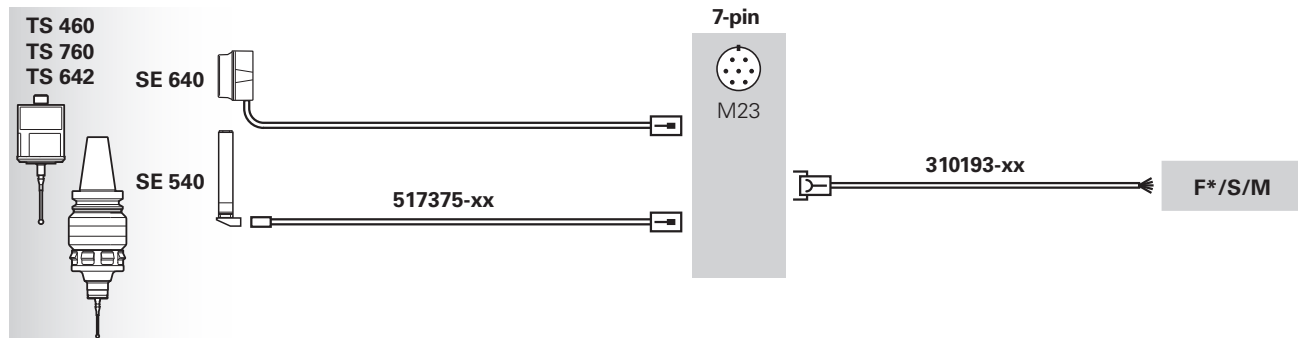

<sup>1), 2)</sup> Pin layouts are identical

# Touch probe adapter cables and connecting cables: for non-HEIDENHAIN interfaces



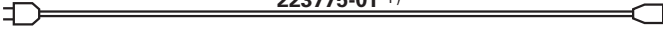
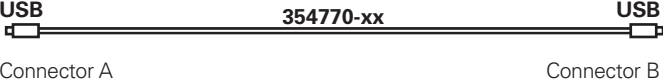
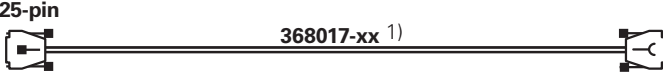

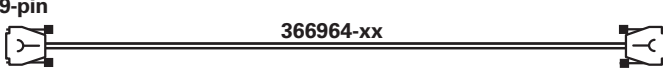
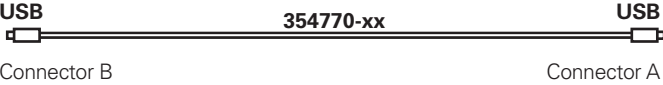
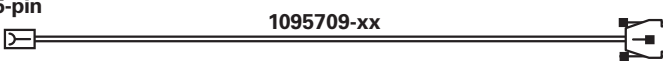



F/S/M = Fanuc / Siemens / Mitsubishi / Mazak, F\* Fanuc High-Speed Skip via UT1 491

# Adapter cables and connecting cables: digital readouts

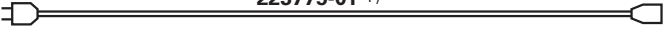
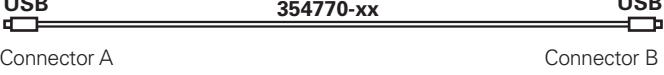
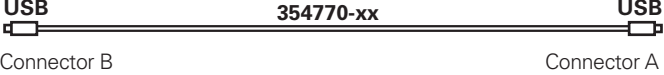
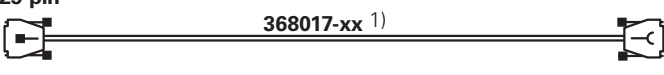
Power cord	 <p>223775-01 <sup>1)</sup></p>	Digital readouts
PC	 <p>USB 354770-xx USB Connector A Connector B</p>	ND 280
V.24 cable to PC	 <p>25-pin 368017-xx <sup>1)</sup> 9-pin</p>	 ND 280
V.24 cable to PC	 <p>9-pin 366964-xx 9-pin</p>	
USB to printer	 <p>USB 354770-xx USB Connector B Connector A</p>	PT 8000 ND 7000
RENISHAW touch probe	 <p>5-pin 1095709-xx 15-pin</p>	 PT 8000 ND 7000

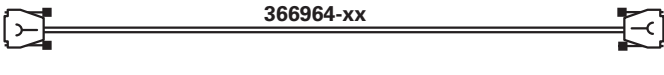
<sup>1)</sup> PVC cable

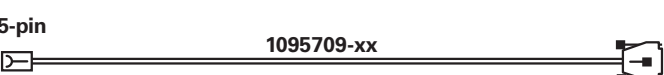
# Adapter cables and connecting cables: evaluation units

Power cord	 <p>223775-01 <sup>1)</sup></p>	Evaluation units
PC	 <p>USB 354770-xx USB</p> <p>Connector A Connector B</p>	ND 287
USB to printer	 <p>USB 354770-xx USB</p> <p>Connector B Connector A</p>	GC 2000
V.24 cable to PC	 <p>25-pin 368017-xx <sup>1)</sup> 9-pin</p>	 ND 287
V.24 cable to PC	 <p>9-pin 366964-xx 15-pin</p>	 GC 2000
RENISHAW touch probe	 <p>5-pin 1095709-xx 15-pin</p>	 GC 2000

<sup>1)</sup> PVC cable

# Output cables: HMC 2 (E30-R2)

## HMC 2 output cables and power cables with encoder communication

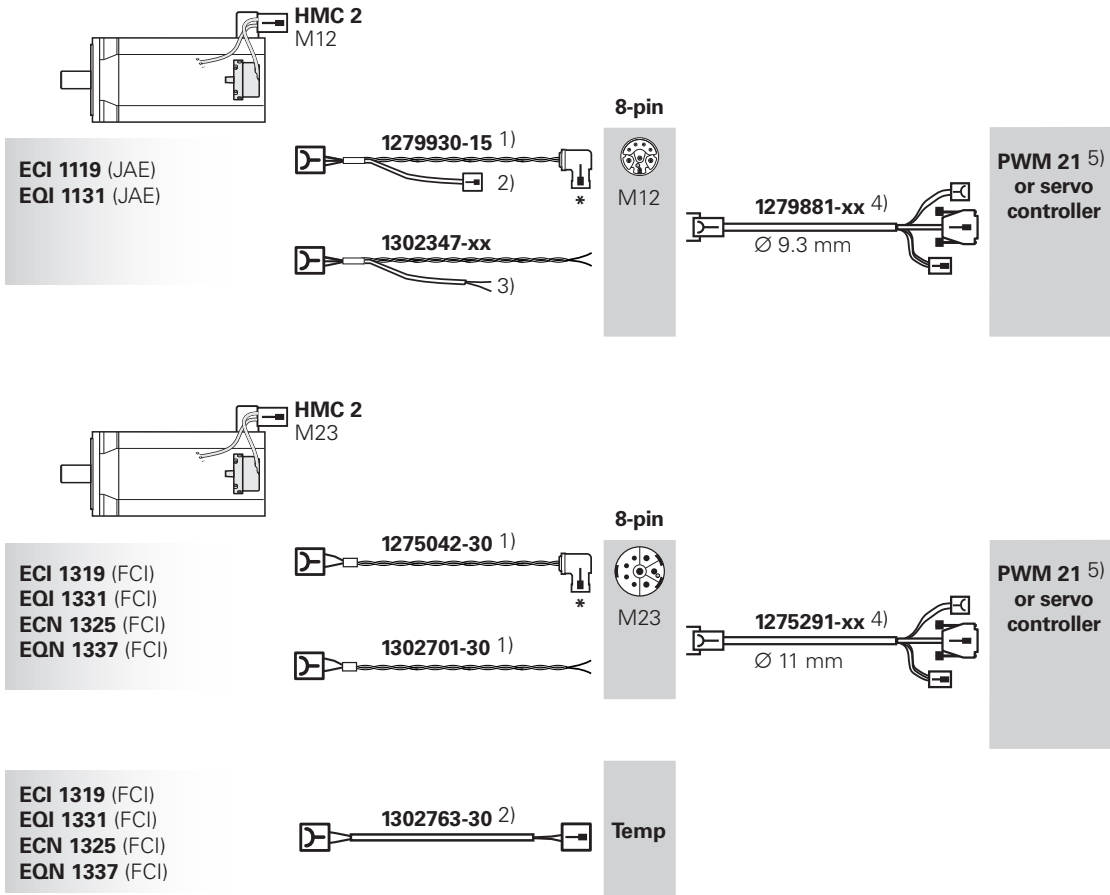

\* SpeedTEC angle flange socket

1) ETFE twisted single wires

2) Wires for temperature sensors: 2 ETFE wires in heat-shrink tubing and 2-pin connector (male)

3) Wires for temperature sensors: 2 ETFE wires in heat-shrink tubing

4) Adapter cable to inspection device

5) SA 1210 signal adapter needed for E30-R2

SpeedTEC is a registered trademark of TE Connectivity Industrial GmbH.



### Further information:

Connecting elements chapter and  
HMC 2 Product Information

# Output cables: HMC 6 (EnDat22)

## HMC 6 output cables and power cables with encoder communication

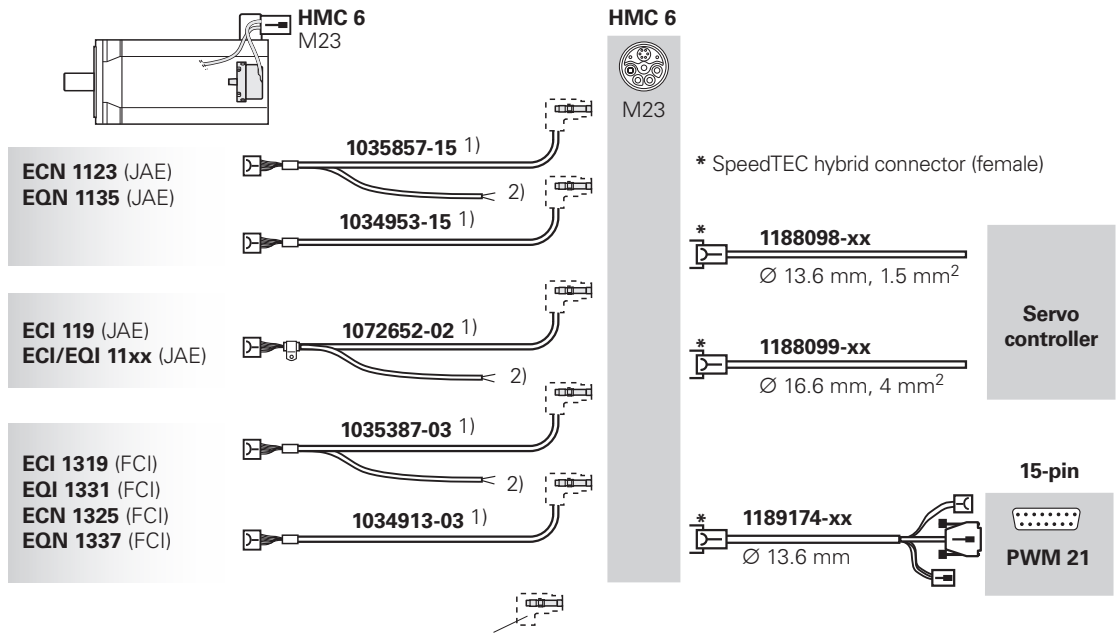

SpeedTEC hybrid flange socket is not included in delivery.

<sup>1)</sup> EPG cable

<sup>2)</sup> Wires for temperature sensors: 2 TPE wires in heat-shrink tubing

SpeedTEC is a registered trademark of TE Connectivity Industrial GmbH.



### Further information:

Connecting elements chapter and  
HMC 6 Product Information

# Output cables: EnDat (EnDat22)

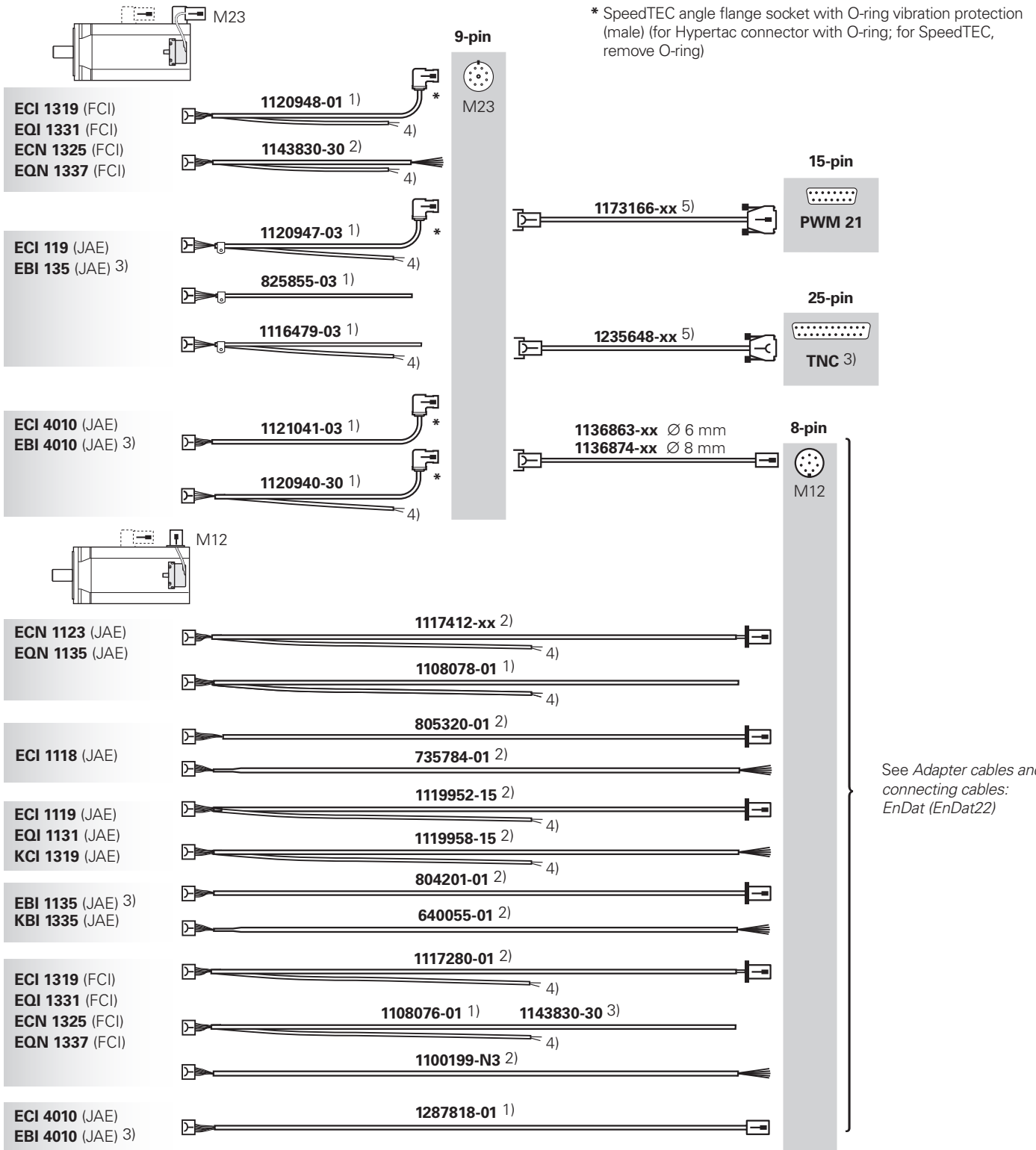

- 1) EPG cable
- 2) TPE single wires in heat-shrink tubing or braided sleeve (without shield)
- 3) The TNC does not support any buffer battery backup multiturn functions
- 4) Wires for temperature sensors: 2 TPE single wires in heat-shrink tubing
- 5) Not for EBI

# Output cables: EnDat (EnDat22)

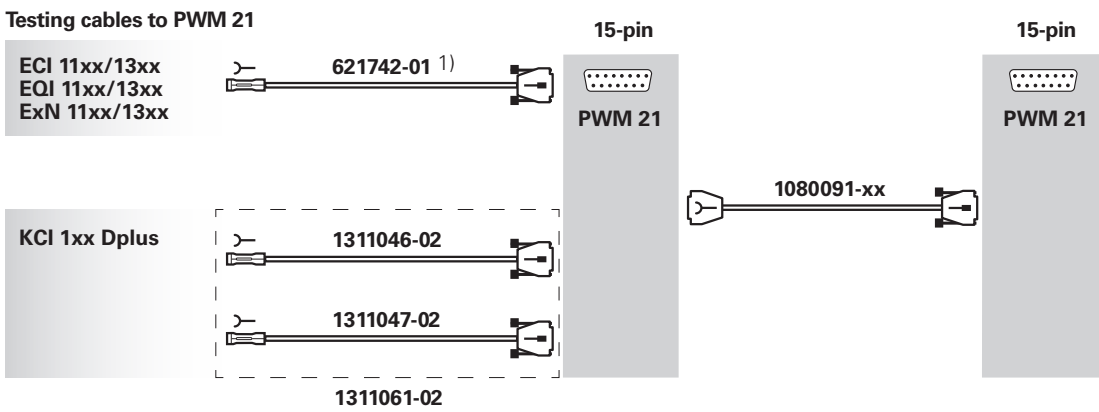
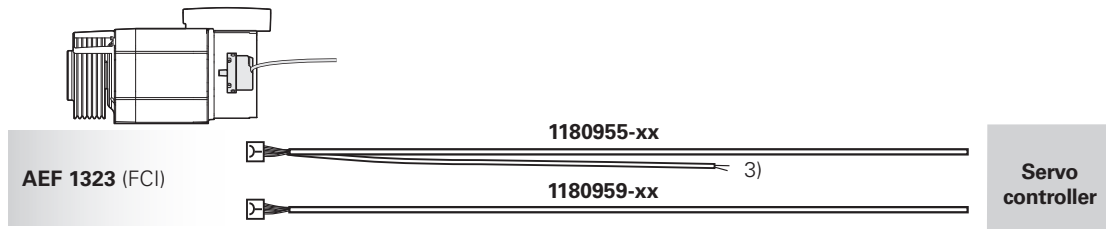
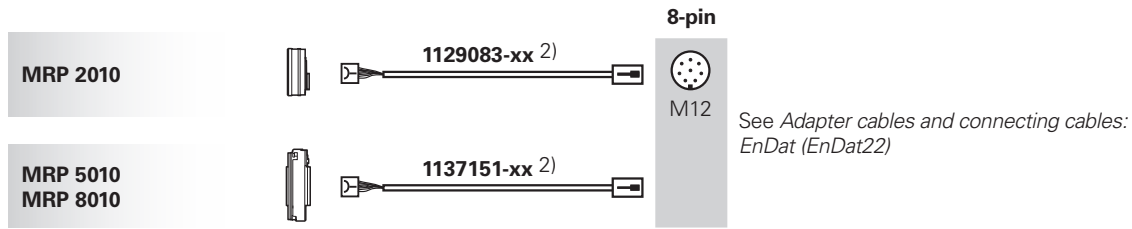

- <sup>1)</sup> EPG cable
- <sup>2)</sup> Cable clamp included
- <sup>3)</sup> Wires for temperature sensors: 2 TPE wires in heat-shrink tubing

SpeedTEC is a registered trademark of TE Connectivity Industrial GmbH

# Output cables: EnDat (EnDat01)

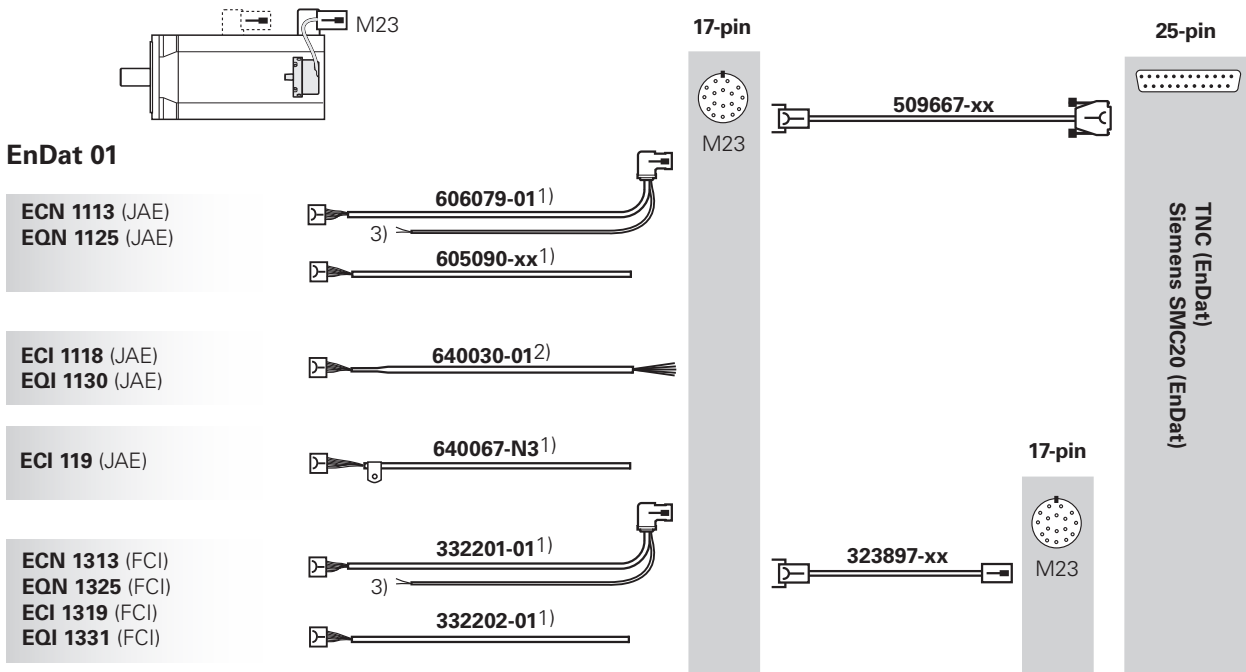

Motors from HEIDENHAIN for connection to TNCs have a different connector layout and must not be connected with the cables listed here. For suitable cables, see the *Cable overview* in the TNC brochure *Information for the Machine Tool Builder*.

## Testing cables to PWM 21

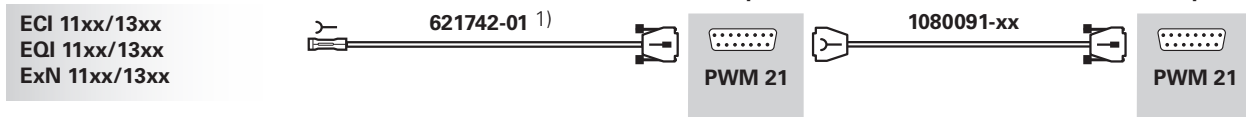

<sup>1)</sup> EPG cable

<sup>2)</sup> TPE single wires in heat-shrink tubing (without shield)

<sup>3)</sup> Wires for temperature sensors: 2 polyolefin wires in heat shrink tubing

# Output cables: DRIVE-CLiQ

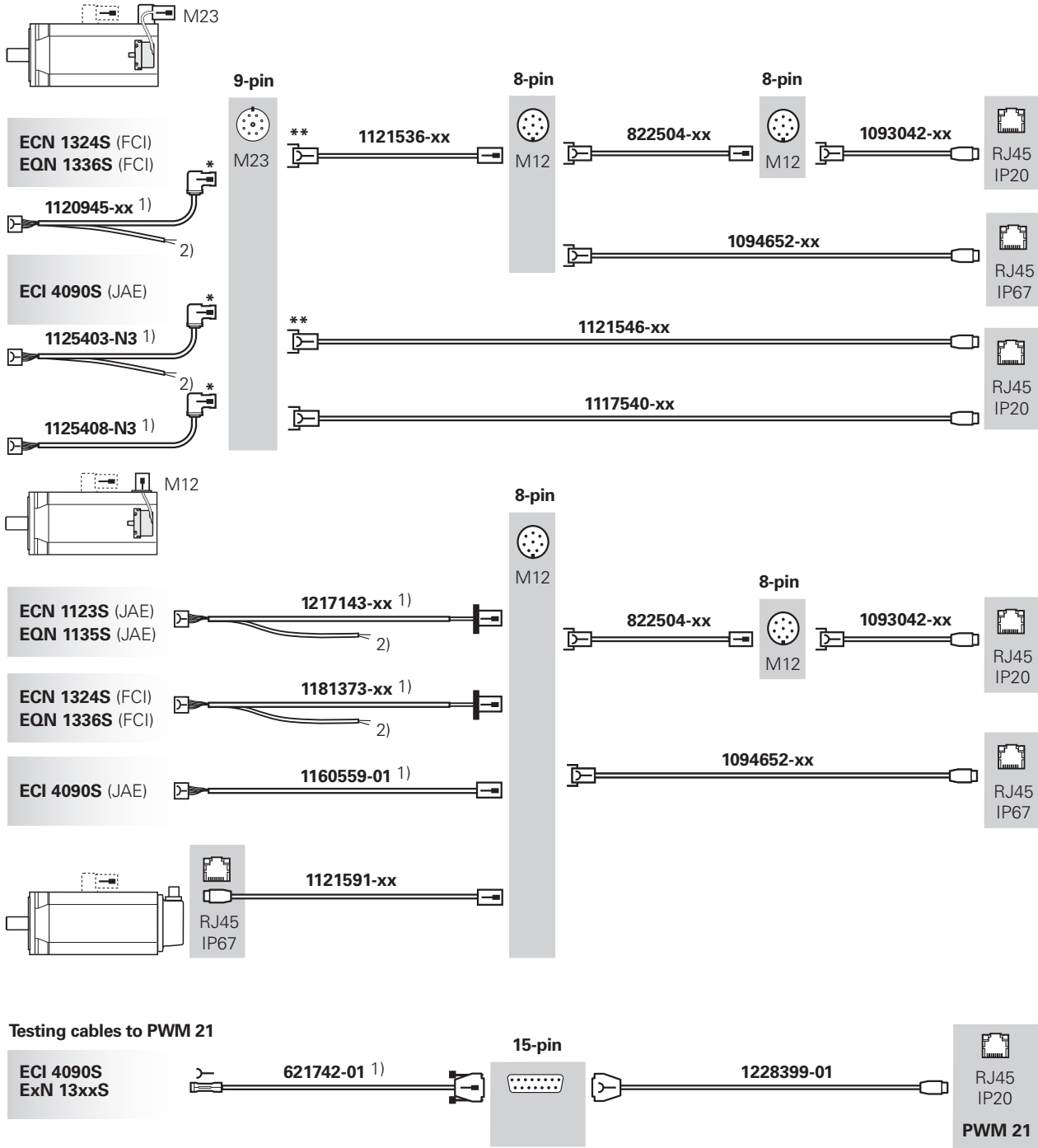

\* SpeedTEC angle-flange socket with O-ring vibration protection (male) (for Hypertac connector with O-ring; for SpeedTEC connector, remove O-ring)  
 \*\* SpeedTEC connector (female)  
 1) EPG cable  
 2) Wires for temperature sensors: 2 TPE wires in heat-shrink tubing

DRIVE-CLiQ is a registered trademark of Siemens Aktiengesellschaft.

# Output cables: 1 V<sub>PP</sub> or TTL

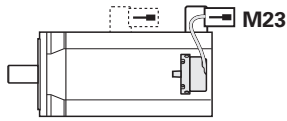

17-pin



ERN 1123 (JAE)

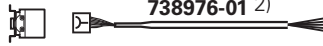

738976-01 <sup>2)</sup>

ERN 1321 (FCI)  
ERN 1381 (FCI)

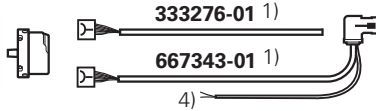

333276-01 <sup>1)</sup>

667343-01 <sup>1)</sup>

<sup>4)</sup>

ERN 1326 (FCI)

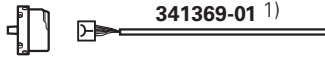

341369-01 <sup>1)</sup>

ERN 1387 (FCI)

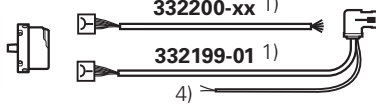

332200-xx <sup>1)</sup>

332199-01 <sup>1)</sup>

<sup>4)</sup>

ERO 14x0 (FCI)

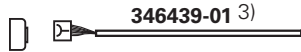

346439-01 <sup>3)</sup>

ERO 12x5 (Hirose)  
ERP 880 (Hirose)

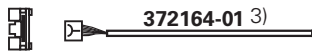

372164-01 <sup>3)</sup>

MRP 2080

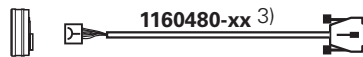

1160480-xx <sup>3)</sup>

15-pin



See Adapter cables and connecting cables: 1 V<sub>PP</sub>

Testing cables to PWM 21

ERN 1387

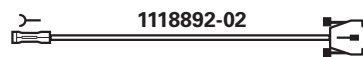

1118892-02

15-pin



PWM 21

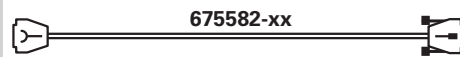

675582-xx

15-pin



PWM 21

<sup>1)</sup> EPG cable

<sup>2)</sup> TPE single wires in heat-shrink tubing (without shield)

<sup>3)</sup> Cable clamp included

<sup>4)</sup> Wires for temperature sensors: 2 polyolefin wires in the heat shrink tubing

# Cable list

## Information about the cable list

The cable list contains all of the available HEIDENHAIN cables. The cables are sorted by ID number in ascending order. The most important selection criteria are listed for each cable.

### Cable diameter

An important criterion for the minimum bending radius of the cable, besides the material of the cable jacket, is the cable diameter (see *General information*).

### Length

HEIDENHAIN cables are available in various predefined lengths. Special lengths are available upon request.

For information on permissible cable lengths, please refer to the *Cable lengths* chapter and the *Interfaces of HEIDENHAIN Encoders* brochure.

### A<sub>P</sub>

The cross section of the supply lines (A<sub>P</sub>) is used to determine the voltage drop in the lines (see the *Interfaces of HEIDENHAIN Encoders* brochure).

For cables with the prefix "2 x" in front of the information about the cable cross section (e.g., 2 x 0.14 mm<sup>2</sup>), two wires are available for U<sub>P</sub> and GND, respectively. These cables can be used for remote sense control. The two wires should be used in parallel.

### Use with

The "Use with" column lists typical interfaces and applications for the HEIDENHAIN pre-assembled cables. These potential applications are merely examples. Further applications are possible after consultation with HEIDENHAIN.

Where relevant, the interfaces are indicated by their names or order designations (possibly in abbreviated form). For more information, please refer to the *Interfaces of HEIDENHAIN Encoders* brochure.









Some product groups are indicated with their product group designations:





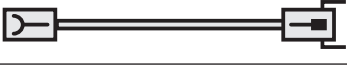
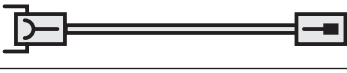
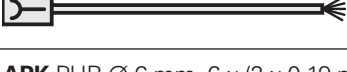
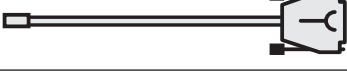

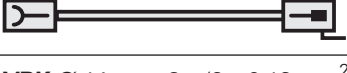



TS/TT: Touch probes  
 ND: Evaluation units and digital readouts  
 QUADRA-CHEK: Evaluation units





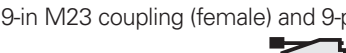





ID		Length	A <sub>P</sub>	Use with
1130994-xx	<b>APK</b> Ø 8 mm; 8-pin M12 connector (female) and 15-pin D-sub connector (female) 	1 m to 50 m	2 x 0.35 mm <sup>2</sup>	EnDat22











Example from the cable list







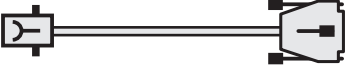





# Cable list sorted by ID number











ID		Length	Ap	Use with
223775-01	<b>Power cable</b> PVC, 3 x 1.0 mm <sup>2</sup> for digital readouts / evaluation units 	3 m	1.0 mm <sup>2</sup>	ND
274543-xx	<b>APK</b> PUR Ø 8 mm, 4 x (2 x 0.16 mm <sup>2</sup> ) + 4 x 0.5 mm <sup>2</sup> ; 6-pin push-pull flange socket and 15-pin D-sub connector (male) 	1 m to 20 m	0.5 mm <sup>2</sup>	TS/TT
274544-xx	<b>VBK</b> PUR Ø 8 mm, 4 x (2 x 0.16 mm <sup>2</sup> ) + 4 x 0.5 mm <sup>2</sup> ; 6-pin push-pull flange socket and stripped cable end 	1 m to 20 m	0.5 mm <sup>2</sup>	TS/TT
289440-xx	<b>APK</b> PUR Ø 8 mm, 4 x (2 x 0.16 mm <sup>2</sup> ) + 4 x 0.5 mm <sup>2</sup> + 4 x 0.16 mm <sup>2</sup> ; 17-pin M23 connector (female) and 25-pin D-sub connector (female) 	1 m to 30 m	2 x 0.5 mm <sup>2</sup>	1 V <sub>PP</sub> + Z1
298399-xx	<b>VBK</b> PUR Ø 8 mm, 4 x (2 x 0.16 mm <sup>2</sup> ) + 4 x 0.5 mm <sup>2</sup> ; 12-pin M23 connector (female) and 12-pin M23 connector (male) 	1 m to 50 m	2 x 0.5 mm <sup>2</sup>	1 V <sub>PP</sub> TTL HTL
298400-xx	<b>VBK</b> PUR Ø 8 mm, 4 x (2 x 0.16 mm <sup>2</sup> ) + 4 x 0.5 mm <sup>2</sup> ; 12-pin M23 coupling (female) and 12-pin M23 connector (male) 	1 m to 50 m	2 x 0.5 mm <sup>2</sup>	1 V <sub>PP</sub> TTL HTL
298401-xx	<b>VBK</b> PUR Ø 8 mm, 4 x (2 x 0.16 mm <sup>2</sup> ) + 4 x 0.5 mm <sup>2</sup> ; 12-pin M23 connector (female) and 12-pin M23 coupling (male) 	1 m to 50 m	2 x 0.5 mm <sup>2</sup>	1 V <sub>PP</sub> TTL HTL
298402-xx	<b>VBK</b> PUR Ø 8 mm, 4 x (2 x 0.16 mm <sup>2</sup> ) + 4 x 0.5 mm <sup>2</sup> ; 12-pin M23 coupling (female) and stripped cable end 	1 m to 50 m	2 x 0.5 mm <sup>2</sup>	1 V <sub>PP</sub> TTL HTL
298429-xx	<b>APK</b> PUR Ø 6 mm, 6 x (2 x 0.19 mm <sup>2</sup> ); 12-pin LS connector (large) and 15-pin D-sub connector (female) 	1 m to 9 m	2 x 0.19 mm <sup>2</sup>	1 V <sub>PP</sub> TTL
309773-xx	<b>VBK</b> PUR Ø 8 mm, 3 x (2 x 0.16 mm <sup>2</sup> ) + 2 x 1.0 mm <sup>2</sup> ; 9-pin M23 connector (female) and 9-pin M23 connector (male) 	1 m to 30 m	1.0 mm <sup>2</sup>	11 µA <sub>PP</sub>
309774-xx	<b>VBK</b> PUR Ø 8 mm, 3 x (2 x 0.16 mm <sup>2</sup> ) + 2 x 1.0 mm <sup>2</sup> ; 9-pin M23 coupling (female) and 9-pin M23 connector (male) 	1 m to 30 m	1.0 mm <sup>2</sup>	11 µA <sub>PP</sub>
309775-xx	<b>VBK</b> Ø 14 mm, 3 x (2 x 0.16 mm <sup>2</sup> ) + 2 x 1.0 mm <sup>2</sup> ; 9-pin M23 coupling (female) and 9-pin M23 connector (male) 	1 m to 20 m	1.0 mm <sup>2</sup>	11 µA <sub>PP</sub>







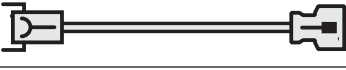



ID		Length	A <sub>p</sub>	Use with
309776-xx	<b>VBK</b> Ø 8 mm, 3 x (2 x 0.16 mm <sup>2</sup> ) + 2 x 1.0 mm <sup>2</sup> ; stripped cable end and 9-pin M23 connector (male) 	1 m to 30 m	1.0 mm <sup>2</sup>	11 µA <sub>PP</sub>
309777-xx	<b>VBK</b> Ø 8 mm, 4 x (2 x 0.16 mm <sup>2</sup> ) + 4 x 0.5 mm <sup>2</sup> ; 12-pin M23 connector (female) and stripped cable end 	1 m to 50 m	2 x 0.5 mm <sup>2</sup>	1 V <sub>PP</sub> TTL HTL
309778-xx	<b>VBK</b> Ø 8 mm, 4 x (2 x 0.16 mm <sup>2</sup> ) + 4 x 0.5 mm <sup>2</sup> + 4 x 0.16 mm <sup>2</sup> ; 17-pin M23 connector (female) and stripped cable end 	1 m to 50 m	2 x 0.5 mm <sup>2</sup>	EnDat01 EnDat02 SSI...
309780-xx	<b>VBK</b> Ø 8 mm, 3 x (2 x 0.16 mm <sup>2</sup> ) + 2 x 1.0 mm <sup>2</sup> ; 9-pin M23 coupling (female) and stripped cable end 	1 m to 30 m	1.0 mm <sup>2</sup>	11 µA <sub>PP</sub>
309781-xx	<b>APK</b> PUR Ø 8 mm, 3 x (2 x 0.16 mm <sup>2</sup> ) + 2 x 1.0 mm <sup>2</sup> ; 9-pin, 2-row D-sub connector (female) and 9-pin M23 connector (male) 	0.5 m to 5 m	1.0 mm <sup>2</sup>	11 µA <sub>PP</sub>
309783-xx	<b>APK</b> Ø 8 mm, 4 x (2 x 0.16 mm <sup>2</sup> ) + 4 x 0.5 mm <sup>2</sup> ; 12-pin M23 coupling (female) and 15-pin D-sub connector (female) 	1 m to 50 m	2 x 0.5 mm <sup>2</sup>	1 V <sub>PP</sub> TTL HTL
309784-xx	<b>APK</b> Ø 8 mm, 4 x (2 x 0.16 mm <sup>2</sup> ) + 4 x 0.5 mm <sup>2</sup> ; 12-pin M23 coupling (female) and 15-pin D-sub connector (male) 	0.5 m to 25 m	2 x 0.5 mm <sup>2</sup>	1 V <sub>PP</sub> TTL HTL
309785-xx	<b>APK</b> Ø 8 mm, 3 x (2 x 0.16 mm <sup>2</sup> ) + 2 x 1.0 mm <sup>2</sup> ; 9-in M23 coupling (female) and 9-pin D-sub connector (male) 	0.5 m to 10 m	1.0 mm <sup>2</sup>	11 µA <sub>PP</sub>
310126-xx	<b>APK</b> Ø 10 mm, 6 x (2 x 0.19 mm <sup>2</sup> ); 12-pin LS connector (large) and 12-pin M23 connector (male) 	1 m to 9 m	2 x 0.19 mm <sup>2</sup>	1 V <sub>PP</sub> TTL
310127-xx	<b>APK</b> Ø 6 mm, 6 x (2 x 0.19 mm <sup>2</sup> ); 12-pin LS connector (large) and 12-pin M23 connector (male) 	1 m to 9 m	2 x 0.19 mm <sup>2</sup>	1 V <sub>PP</sub> TTL
310128-xx	<b>APK</b> Ø 6 mm, 6 x (2 x 0.19 mm <sup>2</sup> ); 12-pin LS connector (large) and 12-pin M23 coupling (male) 	1 m to 9 m	2 x 0.19 mm <sup>2</sup>	1 V <sub>PP</sub> TTL
310131-xx	<b>VBK</b> Ø 6 mm, 6 x (2 x 0.19 mm <sup>2</sup> ); 12-pin LS connector (large) and stripped cable end 	1 m to 9 m	2 x 0.19 mm <sup>2</sup>	1 V <sub>PP</sub> TTL













ID		Length	Ap	Use with
310193-xx	<b>VBK</b> Ø 8 mm, 3 x (2 x 0.14 mm <sup>2</sup> ) + 2 x 0.5 mm <sup>2</sup> ; 7-pin M23 connector (female) and stripped cable end 	3 m to 40 m	0.5 mm <sup>2</sup>	TS/TT
310194-xx	<b>VBK</b> Ø 8 mm, 4 x (2 x 0.16 mm <sup>2</sup> ) + 4 x 0.5 mm <sup>2</sup> ; 7-pin M23 mounted coupling (female) and stripped cable end 	1 m to 30 m	0.5 mm <sup>2</sup>	TS/TT
310195-xx	<b>APK</b> PUR Ø 8 mm, 3 x (2 x 0.14 mm <sup>2</sup> ) + 2 x 1.0 mm <sup>2</sup> ; 9-pin M23 connector (female) and 9-pin D-sub connector (male) 	0.5 m to 5 m	2 x 1.0 mm <sup>2</sup>	11 µA <sub>PP</sub>
310196-xx	<b>APK</b> Ø 8 mm, 4 x (2 x 0.16 mm <sup>2</sup> ) + 4 x 0.5 mm <sup>2</sup> ; 12-pin M23 connector (female) and 15-pin D-sub connector (male) 	0.5 m to 25 m	2 x 0.5 mm <sup>2</sup>	1 V <sub>PP</sub> TTL HTL
310197-xx	<b>APK</b> Ø 8 mm, 3 x (2 x 0.14 mm <sup>2</sup> ) + 2 x 0.5 mm <sup>2</sup> ; 7-pin M23 connector (female) and 15-pin D-sub connector (male) 	1 m to 25 m	0.5 mm <sup>2</sup>	TS/TT
310199-xx	<b>APK</b> Ø 8 mm, 4 x (2 x 0.16 mm <sup>2</sup> ) + 4 x 0.5 mm <sup>2</sup> ; 12-pin M23 connector (female) and 15-pin D-sub connector (female) 	1 m to 50 m	2 x 0.5 mm <sup>2</sup>	1 V <sub>PP</sub> TTL HTL
313119-01	<b>PUR adapter cable</b> Ø 6 mm, 6 x (2 x 0.19 mm <sup>2</sup> ); conversion from 11 µA <sub>PP</sub> to 1 V <sub>PP</sub> ; 15-pin D-sub coupling (male) and 15-pin D-sub connector (female) 	0.5 m	0.19 mm <sup>2</sup>	11 µA <sub>PP</sub>
323897-xx	<b>VBK</b> Ø 8 mm, 4 x (2 x 0.16 mm <sup>2</sup> ) + 4 x 0.5 mm <sup>2</sup> + (4 x 0.16 mm <sup>2</sup> ); 17-pin M23 connector (female) and 17-pin M23 coupling (male) 	1 m to 50 m	2 x 0.5 mm <sup>2</sup>	EnDat01 EnDat02 1 V <sub>PP</sub> + Z1 SSI...
324544-xx	<b>APK</b> Ø 8 mm, 4 x (2 x 0.16 mm <sup>2</sup> ) + 4 x 0.5 mm <sup>2</sup> + (4 x 0.16 mm <sup>2</sup> ); 17-pin M23 connector (female) and 15-pin D-sub connector (male) 	1 m to 25 m	2 x 0.5 mm <sup>2</sup>	EnDat01 EnDat02
331693-xx	<b>APK</b> Ø 8 mm, 4 x (2 x 0.16 mm <sup>2</sup> ) + 4 x 0.5 mm <sup>2</sup> ; 15-pin D-sub connector (female) and 12-pin M23 connector (male) 	1 m to 50 m	2 x 0.5 mm <sup>2</sup>	1 V <sub>PP</sub> TTL
332115-xx	<b>APK</b> Ø 8 mm, 4 x (2 x 0.16 mm <sup>2</sup> ) + 4 x 0.5 mm <sup>2</sup> + (4 x 0.16 mm <sup>2</sup> ); 17-pin M23 connector (female) and 15-pin D-sub connector (female) 	1 m to 50 m	2 x 0.5 mm <sup>2</sup>	EnDat01 EnDat02 SSI...

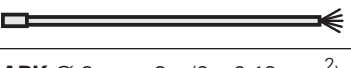



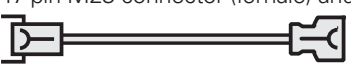

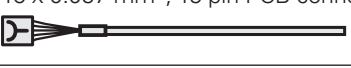

ID		Length	A <sub>P</sub>	Use with
332199-01	<b>AGK ERN 1387</b> Ø 4.5 mm EPG (with shield crimp Ø 6.1 mm), 16 x 0.057 mm <sup>2</sup> and polyolefin wires, 2 x 0.25 mm <sup>2</sup> , for temperature sensor; 14-pin PCB connector and 17-pin M23 angle flange socket (male) 	0.3 m	2 x 0.057 mm <sup>2</sup>	1 V <sub>PP</sub>
332200-01 332200-04	<b>AGK ERN 1387</b> Ø 4.5 mm EPG (with shield crimp Ø 6.1 mm) 16 x 0.057 mm <sup>2</sup> ; 14-pin PCB connector and unstripped cable end 	0.3 m 1 m	2 x 0.057 mm <sup>2</sup>	1 V <sub>PP</sub>
332201-01	<b>AGK ECN 1313/EQN 1325/ECI 1319/EQI 1331</b> Ø 4.5 mm EPG (with shield crimp Ø 6.1 mm), 16 x 0.057 mm <sup>2</sup> and polyolefin wires, 2 x 0.25 mm <sup>2</sup> for temperature sensor; 12-pin PCB connector and 17-pin M23 angle flange socket (male) 	0.3 m	2 x 0.057 mm <sup>2</sup>	EnDat01
332202-01	<b>AGK ECN 1313/EQN 1325/ECI 1319/EQI 1331</b> Ø 4.5 mm EPG (with shield crimp Ø 6.1 mm), 16 x 0.057 mm <sup>2</sup> ; 12-pin PCB connector and unstripped cable end 	0.3 m	2 x 0.057 mm <sup>2</sup>	EnDat01
332433-xx	<b>VBK</b> Ø 8 mm, 4 x (2 x 0.16 mm <sup>2</sup> ) + 4 x 0.5 mm <sup>2</sup> ; 15-pin D-sub connector (female) 	1 m to 50 m	2 x 0.5 mm <sup>2</sup>	1 V <sub>PP</sub> TTL
333276-01	<b>AGK ERN 1381/ERN 1321</b> Ø 4.5 mm EPG (with shield crimp Ø 6.1 mm), 16 x 0.057 mm <sup>2</sup> ; 12-pin PCB connector and unstripped cable end 	0.3 m	2 x 0.057 mm <sup>2</sup>	1 V <sub>PP</sub> TTL
335074-xx	<b>VBK</b> Ø 8 mm, 4 x (2 x 0.16 mm <sup>2</sup> ) + 4 x 0.5 mm <sup>2</sup> ; 15-pin D-sub connector (female) and 15-pin D-sub connector (male) 	1 m to 50 m	2 x 0.5 mm <sup>2</sup>	1 V <sub>PP</sub> TTL
335077-xx	<b>APK</b> Ø 8 mm, 4 x (2 x 0.16 mm <sup>2</sup> ) + 4 x 0.5 mm <sup>2</sup> ; 15-pin D-sub connector (female) and 15-pin D-sub connector (female) 	1 m to 50 m	2 x 0.5 mm <sup>2</sup>	1 V <sub>PP</sub> TTL
335332-xx	<b>APK</b> Ø 8 mm, 4 x (2 x 0.16 mm <sup>2</sup> ) + 4 x 0.5 mm <sup>2</sup> ; 7-pin M23 mounted coupling (female) and 9-pin D-sub connector (male) 	0.5 m to 40 m	0.5 mm <sup>2</sup>	TS/TT
336376-xx	<b>APK</b> Ø 8 mm, 4 x (2 x 0.16 mm <sup>2</sup> ) + 4 x 0.5 mm <sup>2</sup> + (4 x 0.16 mm <sup>2</sup> ); 17-pin M23 connector (female) and 25-pin D-sub connector (female) 	1 m to 50 m	2 x 0.5 mm <sup>2</sup>	EnDat01 EnDat02 SSI...
336847-xx	<b>VBK</b> Ø 8 mm, 4 x (2 x 0.16 mm <sup>2</sup> ) + 4 x 0.5 mm <sup>2</sup> + (4 x 0.16 mm <sup>2</sup> ); 17-pin M23 connector (female) and 17-pin M23 coupling (male) 	1 m to 50 m	2 x 0.5 mm <sup>2</sup>	1 V <sub>PP</sub> + Z1





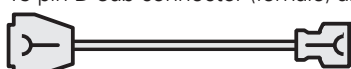

ID		Length	Ap	Use with
340302-xx	<b>VBK</b> Ø 8 mm, 4 x (2 x 0.16 mm <sup>2</sup> ) + 4 x 0.5 mm <sup>2</sup> + (4 x 0.16 mm <sup>2</sup> ); 17-pin M23 connector (female) and 17-pin M23 coupling (male) 	1 m to 50 m	2 x 0.5 mm <sup>2</sup>	EnDat01 EnDat02 SSI...
341369-01	<b>AGK ERN 1326</b> Ø 4.5 mm EPG (with shield crimp Ø 6.1 mm), 16 x 0.057 mm <sup>2</sup> ; 16-pin PCB connector and unstripped cable end 	0.3 m	2 x 0.057 mm <sup>2</sup>	TTL
344228-xx	<b>APK</b> Ø 6 mm, 6 x (2 x 0.19 mm <sup>2</sup> ); 14-pin M12 coupling and 12-pin M23 connector (male) 	1 m to 9 m	2 x 0.19 mm <sup>2</sup>	1 V <sub>PP</sub> TTL
344451-xx	<b>APK</b> Ø 10 mm, 6 x (2 x 0.19 mm <sup>2</sup> ); 14-pin M12 coupling and 12-pin M23 connector (male) 	1 m to 9 m	2 x 0.19 mm <sup>2</sup>	1 V <sub>PP</sub> TTL
346439-01	<b>AGK ERO 14x0 PUR</b> Ø 4.5 mm (with shield crimp Ø 4.3 mm), 4 x (2 x 0.05 mm <sup>2</sup> ) + 4 x 0.16 mm <sup>2</sup> ; 12-pin PCB connector and unstripped cable end (cable clamp included) 	1 m	2 x 0.16 mm <sup>2</sup>	1 V <sub>PP</sub> TTL
349314-xx	<b>VBK</b> Ø 8 mm, 1 x (4 x 0.16 mm <sup>2</sup> ) + 4 x 1.0 mm <sup>2</sup> ; 17-pin M23 connector (female) and 17-pin M23 coupling (male) 	1 m to 15 m	2 x 1.0 mm <sup>2</sup>	Fanuc... Mit...
349687-xx	<b>APK</b> Ø 6 mm, 6 x (2 x 0.19 mm <sup>2</sup> ); 15-pin D-sub connector (female) and 15-pin D-sub connector (female) 	1 m to 7 m	2 x 0.19 mm <sup>2</sup>	1 V <sub>PP</sub> TTL
352611-xx	<b>APK</b> Ø 4.5 mm, 4 x (2 x 0.05 mm <sup>2</sup> ) + 4 x 0.16 mm <sup>2</sup> ; 14-pin M12 coupling and 12-pin M23 connector (male) 	1 m to 9 m	2 x 0.16 mm <sup>2</sup>	1 V <sub>PP</sub> TTL
354319-xx	<b>VBK</b> Ø 6 mm, 6 x (2 x 0.19 mm <sup>2</sup> ); 14-pin M12 coupling and stripped cable end 	1 m to 15 m	2 x 0.19 mm <sup>2</sup>	1 V <sub>PP</sub> TTL
354379-xx	<b>VBK</b> Ø 8 mm, 6 x 2 x 0.16 mm <sup>2</sup> + 4 x 0.5 mm <sup>2</sup> ; 15-pin D-sub connector (female) and 15-pin D-sub connector (male) 	1 m to 20 m	2 x 0.5 mm <sup>2</sup>	1 V <sub>PP</sub> TTL
354411-xx	<b>VBK</b> Ø 8 mm, 6 x 2 x 0.16 mm <sup>2</sup> + 4 x 0.5 mm <sup>2</sup> ; 15-pin D-sub (female) and stripped cable end 	1 m to 20 m	2 x 0.5 mm <sup>2</sup>	1 V <sub>PP</sub> TTL
355186-xx	<b>VBK</b> Ø 6 mm, 6 x (2 x 0.19 mm <sup>2</sup> ); 15-pin D-sub connector (female) and 15-pin D-sub connector (male) 	1 m to 7 m	2 x 0.19 mm <sup>2</sup>	1 V <sub>PP</sub> TTL







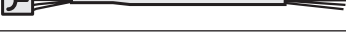
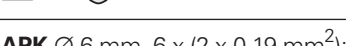
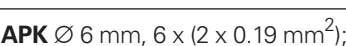
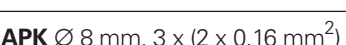
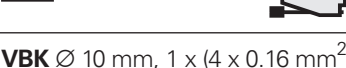
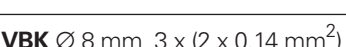
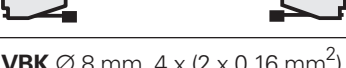



ID		Length	A <sub>P</sub>	Use with
355209-xx	<b>VBK</b> Ø 6 mm, 6 x (2 x 0.19 mm <sup>2</sup> ); 15-pin D-sub connector (female) and stripped cable end 	1 m to 7 m	2 x 0.19 mm <sup>2</sup>	1 V <sub>PP</sub> TTL
355215-xx	<b>APK</b> Ø 6 mm, 6 x (2 x 0.19 mm <sup>2</sup> ); 15-pin D-sub connector (female) and 12-pin M23 connector (male) 	1 m to 7 m	2 x 0.19 mm <sup>2</sup>	1 V <sub>PP</sub> TTL
355397-xx	<b>VBK</b> Ø 6 mm, 6 x (2 x 0.09 mm <sup>2</sup> ) + 4 x 0.16 mm <sup>2</sup> ; 15-pin D-sub connector (female) and 15-pin D-sub connector (male) 	1 m to 7 m	2 x 0.16 mm <sup>2</sup>	1 V <sub>PP</sub> TTL
355398-xx	<b>VBK</b> Ø 6 mm, 6 x (2 x 0.09 mm <sup>2</sup> ) + 4 x 0.16 mm <sup>2</sup> ; 15-pin D-sub connector (female) and stripped cable end 	1 m to 7 m	2 x 0.16 mm <sup>2</sup>	1 V <sub>PP</sub> TTL
360645-xx	<b>APK</b> Ø 6 mm, 6 x (2 x 0.19 mm <sup>2</sup> ); 14-pin M12 coupling and 12-pin M23 coupling (male) 	1 m to 9 m	2 x 0.19 mm <sup>2</sup>	1 V <sub>PP</sub> TTL
360974-xx	<b>APK</b> Ø 6 mm, 6 x (2 x 0.19 mm <sup>2</sup> ); 14-pin M12 coupling and 15-pin D-sub connector (female) 	1 m to 15 m	2 x 0.19 mm <sup>2</sup>	1 V <sub>PP</sub> TTL
366419-xx	<b>APK</b> Ø 6 mm, 2 x (2 x 0.16 mm <sup>2</sup> ) + 4 x 0.5 mm <sup>2</sup> ; 15-pin D-sub connector (female) and 20-pin Mini Delta Ribbon connector (male) 	1 m to 30 m	2 x 0.5 mm <sup>2</sup>	Mit...
366964-xx	<b>V.24 cable (RS-232)</b> for ND 28x, PUR Ø 6 mm, 6 x (2 x 0.19 mm <sup>2</sup> ); 9-pin D-sub connector (female) and 9-pin D-sub connector (female) 	3 m 5 m 10 m	2 x 0.19 mm <sup>2</sup>	ND
367958-xx	<b>APK</b> Ø 6 mm, 2 x (2 x 0.16 mm <sup>2</sup> ) + 4 x 0.5 mm <sup>2</sup> ; 17-pin M23 connector (female) and 20-pin Mini Delta Ribbon connector (male) 	1 m to 25 m	2 x 0.5 mm <sup>2</sup>	Mit...
368017-xx	<b>V.24 cable (RS-232)</b> for ND 28x, PVC Ø 7.1 mm, 8 x 0.25 mm <sup>2</sup> ; 25-pin D-sub connector (male) and 9-pin D-sub connector (female) 	3 m 5 m 10 m	0.25 mm <sup>2</sup>	ND
368172-xx	<b>APK</b> Ø 8 mm, 3 x (2 x 0.16 mm <sup>2</sup> ) + 2 x 1.0 mm <sup>2</sup> ; 9-pin M23 coupling (female) and 15-pin D-sub connector (female) 	1 m to 10 m	1.0 mm <sup>2</sup>	11 µA <sub>PP</sub>











ID		Length	Ap	Use with
368330-xx	<b>VBK</b> Ø 6 mm, 1 x (4 x 0.16 mm <sup>2</sup> ) + 4 x 0.34 mm <sup>2</sup> ; 8-pin M12 connector (female) and 8-pin M12 coupling (male) 	1 m to 50 m	2 x 0.34 mm <sup>2</sup>	TS/TT
372164-01	<b>AGK ERO 12x5/ERP 880</b> , PUR Ø 4.5 mm (with shield crimp Ø 4.3 mm), 4 x (2 x 0.05 mm <sup>2</sup> ) + 4 x 0.16 mm <sup>2</sup> ; 12-pin PCB connector (Hirose) and unstripped cable end (cable clamp included) 	1 m	2 x 0.16 mm <sup>2</sup>	1 V <sub>PP</sub> TTL
372978-xx	<b>APK</b> Ø 8 mm, 4 x (2 x 0.16 mm <sup>2</sup> ) + 4 x 0.5 mm <sup>2</sup> ; 15-pin D-sub connector (female) and 12-pin M23 coupling (male) 	1 m to 30 m	2 x 0.5 mm <sup>2</sup>	1 V <sub>PP</sub> TTL
372979-xx	<b>APK</b> Ø 6 mm, 6 x (2 x 0.19 mm <sup>2</sup> ); 15-pin D-sub connector (female) and 12-pin M23 coupling (male) 	1 m to 7 m	2 x 0.19 mm <sup>2</sup>	1 V <sub>PP</sub> TTL
373289-xx	<b>VBK</b> Ø 6 mm, 1 x (4 x 0.16 mm <sup>2</sup> ) + 4 x 0.34 mm <sup>2</sup> ; 8-pin M12 right-angle connector (female) and 8-pin M12 coupling (male) 	1 m to 50 m	2 x 0.34 mm <sup>2</sup>	TS/TT
387287-xx	<b>APK</b> Ø 6 mm, 6 x (2 x 0.19 mm <sup>2</sup> ); 14-pin M12 coupling and 15-pin D-sub connector (male) 	1 m to 15 m	2 x 0.19 mm <sup>2</sup>	1 V <sub>PP</sub> TTL
509667-xx	<b>APK</b> Ø 8 mm, 4 x (2 x 0.16 mm <sup>2</sup> ) + 4 x 0.5 mm <sup>2</sup> + 4 x 0.14 mm <sup>2</sup> ; 17-pin M23 connector (female) and 25-pin D-sub connector (female) 	1 m to 50 m	2 x 0.5 mm <sup>2</sup>	EnDat01 EnDat02
517375-xx	<b>APK</b> Ø 4.5 mm, 4 x (2 x 0.05 mm <sup>2</sup> ) + 1 x 0.05 mm <sup>2</sup> ; 8-pin M9 connector (female) and 7-pin M23 coupling (male) 	1 m to 10 m	0.05 mm <sup>2</sup>	TS/TT
517376-xx	<b>APK</b> Ø 4.5 mm, 4 x (2 x 0.05 mm <sup>2</sup> ) + 1 x 0.05 mm <sup>2</sup> ; 8-pin M9 connector (female) and 15-pin D-sub connector (male) 	6 m to 30 m	0.05 mm <sup>2</sup>	TS/TT
533631-xx	<b>APK</b> Ø 6 mm, 6 x (2 x 0.19 mm <sup>2</sup> ); 14-pin M12 coupling and 17-pin M23 coupling (male) 	1 m to 9 m	2 x 0.19 mm <sup>2</sup>	EnDat01 EnDat02 SSI...
534855-xx	<b>APK</b> Ø 8 mm, 2 x (2 x 0.16 mm <sup>2</sup> ) + 4 x 1.0 mm <sup>2</sup> ; 17-pin M23 connector (female) and 15-pin Mini Delta Ribbon connector (female) 	1 m to 30 m	2 x 1.0 mm <sup>2</sup>	Fanuc...

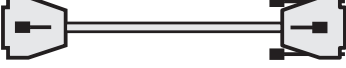







ID		Length	A <sub>P</sub>	Use with
539878-xx	<b>APK</b> Ø 10 mm, 6 x (2 x 0.19 mm <sup>2</sup> ); 14-pin M12 coupling and 15-pin D-sub connector (female) 	1 m to 20 m	2 x 0.19 mm <sup>2</sup>	1 V <sub>PP</sub> TTL
540660-05	<b>VBK</b> PVC Ø 5.1 mm, 6 x 0.25 mm <sup>2</sup> ; for communication between ND 2100 G and PC with QUADRA-CHEK Wedge; with 9-pin D-sub connector (female) 	3 m	–	ND
556558-xx	<b>APK</b> Ø 8 mm, 4 x (2 x 0.16 mm <sup>2</sup> ) + 4 x 0.5 mm <sup>2</sup> ; 12-pin M23 connector (female) and 15-pin Mini Delta Ribbon connector (female) 	1 m to 30 m	2 x 0.5 mm <sup>2</sup>	Fanuc...
558362-xx	<b>APK</b> Ø 10 mm, 6 x (2 x 0.19 mm <sup>2</sup> ); 14-pin M12 coupling and 17-pin M23 coupling (male) 	1 m to 9 m	2 x 0.19 mm <sup>2</sup>	EnDat01 EnDat02 SSI...
558432-xx	<b>VBK</b> Ø 6 mm, 6 x (2 x 0.19 mm <sup>2</sup> ); 14-pin M12 coupling and stripped cable end 	1 m to 15 m	2 x 0.19 mm <sup>2</sup>	EnDat01 EnDat02
558714-xx	<b>APK</b> Ø 6 mm, 6 x (2 x 0.19 mm <sup>2</sup> ); 14-pin M12 coupling and 15-pin D-sub connector (female) 	1 m to 20 m	2 x 0.19 mm <sup>2</sup>	EnDat01 EnDat02 SSI...
558727-xx	<b>APK</b> Ø 6 mm, 6 x (2 x 0.19 mm <sup>2</sup> ); 14-pin M12 coupling and 25-pin D-sub connector (female) 	1 m to 20 m	2 x 0.19 mm <sup>2</sup>	EnDat01 EnDat02 SSI...
572822-xx	<b>APK</b> Ø 8 mm, 4 x (2 x 0.16 mm <sup>2</sup> ) + 4 x 0.5 mm <sup>2</sup> ; 12-pin M23 connector (female) and 15-pin Mini Delta Ribbon connector (female) 	1 m to 30 m	2 x 0.5 mm <sup>2</sup>	Fanuc...
573661-xx	<b>APK</b> Ø 8 mm, 2 x (2 x 0.16 mm <sup>2</sup> ) + 4 x 1.0 mm <sup>2</sup> ; 17-pin M23 connector (female) and 10-pin Mini Delta Ribbon connector (female) 	1 m to 30 m	2 x 1.0 mm <sup>2</sup>	Mit...
588552-xx	<b>APK</b> Ø 10 mm, 6 x (2 x 0.19 mm <sup>2</sup> ); 12-pin LS connector (large) and 15-pin D-sub connector (female) 	1 m to 9 m	2 x 0.19 mm <sup>2</sup>	1 V <sub>PP</sub> TTL
605090-01 605090-02	<b>AGK ECN 1113/EQN 1125</b> Ø 4.5 mm EPG (with shield crimp Ø 4.3 mm), 16 x 0.057 mm <sup>2</sup> ; 15-pin PCB connector and unstripped cable end 	0.3 m 2 m	2 x 0.057 mm <sup>2</sup>	EnDat01
606079-01	<b>AGK ECN 1113/EQN 1125</b> Ø 4.5 mm EPG (with shield crimp Ø 4.3 mm), 16 x 0.057 mm <sup>2</sup> and polyolefin wires, 2 x 0.25 mm <sup>2</sup> for temperature sensor; 15-pin PCB connector and 17-pin M23 angle flange socket (male) 	0.3 m	2 x 0.057 mm <sup>2</sup>	EnDat01





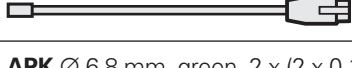
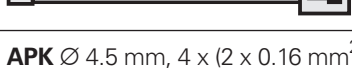

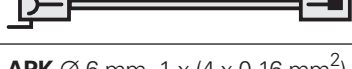

ID		Length	Ap	Use with
606317-xx	<b>VBK</b> Ø 6 mm, 1 x (4 x 0.16 mm <sup>2</sup> ) + 4 x 0.34 mm <sup>2</sup> ; 8-pin M12 right-angle connector (female) and unstripped cable end 	1 m to 50 m	2 x 0.34 mm <sup>2</sup>	TS/TT
617484-xx	<b>APK in braided shield</b> Ø 6.6 mm, 6 x (2 x 0.19 mm <sup>2</sup> ); 14-pin M12 coupling and 9-pin D-sub connector (male) 	1 m to 9 m	2 x 0.19 mm <sup>2</sup>	TTL
617513-xx	<b>APK</b> Ø 8 mm, 4 x (2 x 0.16 mm <sup>2</sup> ) + 4 x 0.5 mm <sup>2</sup> ; 12-pin M23 coupling (female) and 9-pin D-sub connector (male) 	1 m to 30 m	2 x 0.5 mm <sup>2</sup>	TTL
621742-01	<b>AGK ECI 11xx/ECI 13xx/EQI 11xx/EQI 13xx/ExN 11xx/ExN 13xx</b> , Ø 4.5 mm EPG 16 x 0.057 mm <sup>2</sup> ; 12-pin PCB connector with strain relief and 15-pin D-sub connector (male), including three 12-pin adapter connectors and three 15-pin adapter connectors; testing cable for PWM 21 	2 m	2 x 0.057 mm <sup>2</sup>	EnDat01 EnDat22
626015-xx	<b>APK</b> Ø 8 mm, 4 x (2 x 0.16 mm <sup>2</sup> ) + 4 x 0.5 mm <sup>2</sup> ; 12-pin M23 connector (female) and 9-pin D-sub connector (male) 	1 m to 50 m	2 x 0.5 mm <sup>2</sup>	TTL
628184-xx	<b>APK</b> Ø 6 mm, 2 x (2 x 0.16 mm <sup>2</sup> ) + 4 x 0.5 mm <sup>2</sup> ; 15-pin D-sub connector (female) and 15-pin Mini Delta Ribbon connector (female) 	1 m to 30 m	2 x 0.5 mm <sup>2</sup>	Fanuc...
630856-xx	<b>APK</b> Ø 6 mm, 4 x (2 x 0.16 mm <sup>2</sup> ) + 4 x 0.5 mm <sup>2</sup> ; 15-pin D-sub connector (female) and 10-pin Mini Delta Ribbon connector (female) 	1 m to 30 m	2 x 0.5 mm <sup>2</sup>	Mit...
633608-xx	<b>APK</b> Ø 4.5 mm; 8-pin M9 connector (female) and 15-pin D-sub connector (male) 	1 m to 30 m	0.09 mm <sup>2</sup>	TS/TT
633611-xx	<b>APK</b> Ø 6 mm, 6 x (2 x 0.19 mm <sup>2</sup> ); 7-pin M23 connector (female) and 15-pin D-sub connector (male) 	1 m to 40 m	0.09 mm <sup>2</sup>	TS/TT
633613-xx	<b>APK</b> Ø 8 mm, 4 x (2 x 0.16 mm <sup>2</sup> ) + 4 x 0.5 mm <sup>2</sup> ; 6-pin push-pull flange socket and 15-pin D-sub connector (male) 	1 m to 20 m	0.19 mm <sup>2</sup>	TS/TT











ID		Length	A <sub>P</sub>	Use with
633616-xx	<b>APK</b> Ø 6 mm, 6 x (2 x 0.19 mm <sup>2</sup> ); 7-pin M23 mounted coupling (female) and 15-pin D-sub connector (male) 	1 m to 40 m	0.09 mm <sup>2</sup>	TS/TT
633811-xx	<b>VBK</b> Ø 6 mm, 6 x (2 x 0.09 mm <sup>2</sup> ) + 4 x 0.16 mm <sup>2</sup> ; 15-pin D-sub connector (female) and 15-pin D-sub connector (male) 	1 m to 10 m	2 x 0.16 mm <sup>2</sup>	1 V <sub>PP</sub> TTL
634265-xx	<b>VBK</b> Ø 6 mm, 1 x (4 x 0.16 mm <sup>2</sup> ) + 4 x 0.34 mm <sup>2</sup> ; 8-pin M12 connector (female) and unstripped cable end 	1 m to 50 m	2 x 0.34 mm <sup>2</sup>	TS/TT
640030-01	<b>AGK ECI 1118/EQI 1130</b> , single wires with heat-shrink tubing (without shield), 12 x 0.16 mm <sup>2</sup> ; 15-pin PCB connector and stripped cable end 	0.15 m	2 x 0.16 mm <sup>2</sup>	EnDat01
640055-01	<b>AGK EBI 1135</b> , single-wires with heat-shrink tubing (without shield), 8 x 0.16 mm <sup>2</sup> ; 15-pin PCB connector and stripped cable end 	0.15 m	2 x 0.16 mm <sup>2</sup>	EnDat22
640067-N3	<b>AGK ECI 119</b> , Ø 4.5 mm EPG, 16 x 0.057 mm <sup>2</sup> ; 15-pin PCB connector and unstripped cable end (cable clamp mounted) 	0.3 m	2 x 0.057 mm <sup>2</sup>	EnDat01
643450-xx	<b>APK</b> Ø 6 mm, 6 x (2 x 0.19 mm <sup>2</sup> ); 12-pin M12 quick connector and 17-pin M23 coupling (male) 	1 m to 20 m	2 x 0.19 mm <sup>2</sup>	EnDat02
645200-xx	<b>APK</b> Ø 6 mm, 6 x (2 x 0.19 mm <sup>2</sup> ); 12-pin M12 connector (female) and 12-pin M23 connector (male) 	1 m to 20 m	2 x 0.19 mm <sup>2</sup>	1 V <sub>PP</sub>
653231-xx	<b>APK</b> Ø 8 mm, 3 x (2 x 0.16 mm <sup>2</sup> ) + 2 x 1.0 mm <sup>2</sup> ; 9-pin M23 coupling (female) and 15-pin D-sub connector (male) 	0.2 m 1 m to 10 m	1.0 mm <sup>2</sup>	11 µA <sub>PP</sub>
660042-xx	<b>VBK</b> Ø 10 mm, 1 x (4 x 0.16 mm <sup>2</sup> ) + 4 x 0.34 mm <sup>2</sup> ; 8-pin M12 connector (female) and 8-pin M12 coupling (male) 	0.5 m to 50 m	0.34 mm <sup>2</sup>	TS/TT
663508-xx	<b>VBK</b> Ø 8 mm, 3 x (2 x 0.14 mm <sup>2</sup> ) + 2 x 0.5 mm <sup>2</sup> ; 15-pin D-sub connector (female) and 15-pin D-sub connector (male) 	1 m to 10 m	0.5 mm <sup>2</sup>	TS/TT
663511-xx	<b>VBK</b> Ø 8 mm, 4 x (2 x 0.16 mm <sup>2</sup> ) + 4 x 0.5 mm <sup>2</sup> ; 9-pin D-sub connector (female) and 9-pin D-sub connector (male) 	1 m to 10 m	0.5 mm <sup>2</sup>	TS/TT









ID		Length	Ap	Use with
663631-xx	<b>APK</b> Ø 6 mm, 6 x (2 x 0.19 mm <sup>2</sup> ); 12-pin M12 connector (female) and 15-pin D-sub connector (male) 	1 m to 20 m	0.19 mm <sup>2</sup>	TS/TT
664211-xx	<b>VBK</b> Ø 6 mm, 6 x (2 x 0.19 mm <sup>2</sup> ); 12-pin M12 connector (female) and 12-pin M12 coupling (male) 	1 m to 20 m	0.19 mm <sup>2</sup>	1 V <sub>PP</sub> TS/TT
667343-01	<b>AGK ERN 1381/ERN 1321</b> , Ø 4.5 mm EPG (with shield crimp Ø 6.1 mm), 16 x 0.057 mm <sup>2</sup> and polyolefin wires, 2 x 0.25 mm <sup>2</sup> for temperature sensor; 12-pin PCB connector and 17-pin M23 angle flange socket (male) 	0.3 m	2 x 0.057 mm <sup>2</sup>	1 V <sub>PP</sub> TTL
672625-xx	<b>APK</b> Ø 10 mm, 6 x (2 x 0.19 mm <sup>2</sup> ); 14-pin M12 coupling and 15-pin D-sub connector (male) 	1 m to 20 m	2 x 0.19 mm <sup>2</sup>	1 V <sub>PP</sub> TTL
675582-xx	<b>VBK</b> Ø 8 mm, 4 x (2 x 0.16 mm <sup>2</sup> ) + 4 x 0.5 mm <sup>2</sup> + 4 x 0.16 mm <sup>2</sup> ; 15-pin D-sub connector (female) and 15-pin D-sub connector (male) 	1 m to 50 m	2 x 0.5 mm <sup>2</sup>	1 V <sub>PP</sub> + Z1 EnDat02
681186-xx	<b>VBK</b> Ø 6 mm, 6 x (2 x 0.19 mm <sup>2</sup> ); 12-pin quick connector and unstripped cable end 	1 m to 20 m	2 x 0.19 mm <sup>2</sup>	EnDat02
701919-xx	<b>APK</b> Ø 8 mm, 3 x (2 x 0.14 mm <sup>2</sup> ) + 2 x 0.5 mm <sup>2</sup> ; 15-pin, 3-row D-sub connector (female) and 15-pin, 2-row D-sub connector (male) 	1 m to 20 m	0.5 mm <sup>2</sup>	TS/TT
716905-0A	<b>APK</b> Ø 8 mm, 3 x (2 x 0.16 mm <sup>2</sup> ) + 2 x 1.0 mm <sup>2</sup> ; 9-pin M23 coupling (female) and 9-pin D-sub connector (male) 	0.5 m	1.0 mm <sup>2</sup>	11 µA <sub>PP</sub>
727658-xx	<b>APK</b> Ø 6 mm, 6 x (2 x 0.19 mm <sup>2</sup> ); 12-pin M12 quick connector and 15-pin D-sub connector (female) 	1 m to 20 m	2 x 0.19 mm <sup>2</sup>	EnDat01 EnDat02
729681-xx	<b>APK</b> Ø 4.5 mm, 1 x (4 x 0.09 mm <sup>2</sup> ) + 4 x 0.16 mm <sup>2</sup> ; 12-pin M12 quick connector and 8-pin M12 coupling (male) 	1 m to 20 m	2 x 0.16 mm <sup>2</sup>	EnDat22 Fanuc... Mit... Pana... YEC...
735210-xx	<b>APK</b> Ø 4.5 mm, 4 x (2 x 0.05 mm <sup>2</sup> ) + 4 x 0.16 mm <sup>2</sup> ; 14-pin M12 coupling and 9-pin D-sub connector (male) 	1 m to 9 m	2 x 0.16 mm <sup>2</sup>	TTL





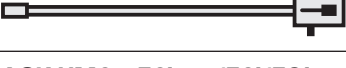





ID		Length	A <sub>p</sub>	Use with
735541-xx	<b>VBK</b> Ø 8 mm, 6 x (2 x 0.16 mm <sup>2</sup> ) + 4 x 0.5 mm <sup>2</sup> ; 15-pin D-sub connector (female) and 15-pin D-sub connector (male), with programming line for mounting the LIP 2xx 	1 m to 6 m	2 x 0.5 mm <sup>2</sup>	1 V <sub>PP</sub> TTL
735784-01	<b>AGK ECI 1118</b> , single-wires with heat-shrink tubing (without shield), 6 x 0.16 mm <sup>2</sup> ; 15-pin PCB connector and stripped cable end 	0.15 m	2 x 0.16 mm <sup>2</sup>	EnDat22
735961-xx	<b>APK</b> Ø 6 mm, 6 x (2 x 0.19 mm <sup>2</sup> ); 12-pin M12 quick connector and 25-pin D-sub connector (female) 	1 m to 20 m	2 x 0.19 mm <sup>2</sup>	EnDat02
738681-N5	<b>APK</b> Ø 8 mm, 3 x (2 x 0.16 mm <sup>2</sup> ) + 2 x 1.0 mm <sup>2</sup> ; 15-pin D-sub connector (male) and 15-pin D-sub connector (male); testing cable for PWM 21/PWT 100 	0.5 m	1.0 mm <sup>2</sup>	11 µA <sub>PP</sub>
738976-01	<b>AGK ERN 1123</b> , single-wires with heat-shrink tubing (without shield), 14 x 0.16 mm <sup>2</sup> ; 15-pin PCB connector and stripped cable end 	0.15 m	2 x 0.16 mm <sup>2</sup>	TTL
739098-N5	<b>APK</b> Ø 8 mm, 4 x (2 x 0.16 mm <sup>2</sup> ) + 4 x 0.5 mm <sup>2</sup> ; 15-pin D-sub connector (male) and 15-pin D-sub connector (male); testing cable for PWM 21/PWT 100 	0.5 m	2 x 0.5 mm <sup>2</sup>	1 V <sub>PP</sub> TTL HTL
745454-xx	<b>APK</b> Ø 6 mm, 1 x (4 x 0.16 mm <sup>2</sup> ) + 4 x 0.34 mm <sup>2</sup> ; 8-pin M12 connector (female) and 15-pin D-sub connector (male) 	1 m to 30 m	0.34 mm <sup>2</sup>	TS/TT
745894-xx	<b>VBK</b> Ø 8 mm, 2 x (2 x 0.24 mm <sup>2</sup> ) + 2 x (2 x 0.35 mm <sup>2</sup> ); 8-pin M12 connector (female) and 8-pin M12 coupling (male) 	1 m to 50 m	2 x 0.35 mm <sup>2</sup>	EnDat22 Fanuc... Mit... Pana... YEC.. TS/TT
747400-xx	<b>APK</b> , spiral cable, 4 x 0.14 mm <sup>2</sup> ; 8-pin M12 connector (female) and 6-pin push-pull connector 	1 m to 3 m	0.14 mm <sup>2</sup>	TS/TT
754232-xx	<b>APK</b> Ø 6 mm, 6 x (2 x 0.19 mm <sup>2</sup> ); 14-pin M12 coupling and 25-pin D-sub connector (female) 	1 m to 9 m	2 x 0.19 mm <sup>2</sup>	1 V <sub>PP</sub> TTL
754240-xx	<b>APK PUR</b> with braided shield Ø 6.6 mm, 6 x (2 x 0.19 mm <sup>2</sup> ); 14-pin M12 coupling and 25-pin D-sub connector (female) 	1 m to 9 m	2 x 0.19 mm <sup>2</sup>	1 V <sub>PP</sub> TTL





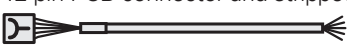



ID		Length	Ap	Use with
754299-xx	<b>APK</b> Ø 10 mm, 6 x (2 x 0.19 mm <sup>2</sup> ); 14-pin M12 coupling and 25-pin D-sub connector (female) 	1 m to 9 m	2 x 0.19 mm <sup>2</sup>	1 V <sub>PP</sub> TTL
758082-xx	<b>APK</b> Ø 8 mm, 4 x (2 x 0.16 mm <sup>2</sup> ) + 4 x 0.5 mm <sup>2</sup> ; 12-pin M23 connector (female) and 25-pin D-sub connector (female) 	1 m to 50 m	2 x 0.5 mm <sup>2</sup>	1 V <sub>PP</sub> TTL HTL
801285-xx	<b>VBK</b> Ø 6 mm, 6 x (2 x 0.19 mm <sup>2</sup> ); 12-pin M12 connector (female) and stripped cable end 	1 m to 20 m	0.19 mm <sup>2</sup>	TS/TT
804201-01	<b>AGK EBI 1135</b> , TPE single wires with braided sleeve (without shield), 8 x 0.16 mm <sup>2</sup> ; 15-pin PCB connector and 8-pin straight M12 flange socket (male) 	0.15 m	2 x 0.16 mm <sup>2</sup>	EnDat22
805320-01	<b>AGK ECI 1118</b> , TPE single wires with braided sleeve (without shield), 6 x 0.16 mm <sup>2</sup> ; 15-pin PCB connector and 8-pin straight M12 flange socket (male) 	0.15 m	2 x 0.16 mm <sup>2</sup>	EnDat22
805375-xx	<b>APK</b> Ø 6.8 mm, green, 2 x (2 x 0.17 mm <sup>2</sup> ) + 1 x (2 x 0.24 mm <sup>2</sup> ); 14-pin M12 mating element and RJ45 connector 	1 m to 30 m	0.24 mm <sup>2</sup>	DQ...
805452-xx	<b>APK</b> Ø 6.8 mm, green, 2 x (2 x 0.17 mm <sup>2</sup> ) + 1 x (2 x 0.24 mm <sup>2</sup> ); 14-pin M12 coupling and 8-pin M12 coupling (male) 	1 m to 20 m	0.24 mm <sup>2</sup>	DQ...
808976-xx	<b>APK</b> Ø 4.5 mm, 4 x (2 x 0.16 mm <sup>2</sup> ); 15-pin D-sub connector (female) and 6-pin Mini Delta Ribbon connector (female) 	1 m to 6 m	2 x 0.16 mm <sup>2</sup>	YEC...
816675-xx	<b>APK</b> Ø 11.1 mm, 2 x (2 x 0.17 mm <sup>2</sup> ) + 1 x (2 x 0.24 mm <sup>2</sup> ); 14-pin M12 coupling and 8-pin M12 coupling (male) 	1 m to 20 m	0.24 mm <sup>2</sup>	DQ...
822504-xx	<b>VBK</b> Ø 6.8 mm, green, 2 x (2 x 0.17 mm <sup>2</sup> ) + 1 x (2 x 0.24 mm <sup>2</sup> ); 8-pin M12 connector (female) and 8-pin M12 coupling (male) 	1 m to 30 m	0.24 mm <sup>2</sup>	DQ...
823924-xx	<b>APK</b> Ø 6 mm, 1 x (4 x 0.16 mm <sup>2</sup> ) + 4 x 0.34 mm <sup>2</sup> ; 8-pin M12 connector (female) and 15-pin, 3-row D-sub connector (male) 	1 m to 20 m	2 x 0.34 mm <sup>2</sup>	TS/TT
825855-03	<b>AGK ECI 119 / EBI 135</b> , Ø 4.5 mm EPG (cable clamp mounted onto crimp sleeve), 4 x (2 x 0.16 mm <sup>2</sup> ); 15-pin PCB connector and unstripped cable end 	0.3 m	2 x 0.16 mm <sup>2</sup>	EnDat22



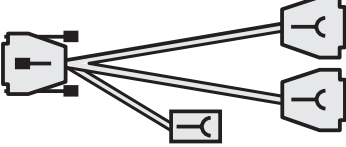
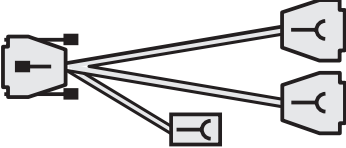







ID		Length	A <sub>p</sub>	Use with
1034913-03	<b>AGK HMC 6 ECI 1319/EQI 1331 Gen. 3/ECN 1325/EQN 1337</b> , Ø 3.7 mm EPG (with shield crimp Ø 6.1 mm), 1 x (4 x 0.06 mm <sup>2</sup> ) + 4 x 0.06 mm <sup>2</sup> ; 12-pin PCB connector and 6-pin contact insert for hybrid connecting element (male) 	0.3 m	2 x 0.06 mm <sup>2</sup>	EnDat22
1034953-15	<b>AGK HMC 6 ECN 1123/EQN 1135</b> , Ø 3.7 mm EPG, 1 x (4 x 0.06 mm <sup>2</sup> ) + 4 x 0.06 mm <sup>2</sup> ; 15-pin PCB connector and 6-pin contact inset for hybrid connecting element (male) 	0.15 m	0.06 mm <sup>2</sup>	EnDat22
1035387-03	<b>AGK HMC 6 ECI 1319/EQI 1331 Gen. 3/ECN 1325/EQN 1337</b> , Ø 3.7 mm EPG (with shield crimp Ø 6.1 mm), 1 x (4 x 0.06 mm <sup>2</sup> ) + 4 x 0.06 mm <sup>2</sup> with TPE wires, 2 x 0.16 mm <sup>2</sup> for temperature sensor; 16-pin PCB connector (12+4) and 6-pin contact insert for hybrid connecting element (male) 	0.3 m	0.06 mm <sup>2</sup>	EnDat22
1035857-15	<b>AGK HMC 6 ECN 1123/EQN 1135</b> , Ø 3.7 mm EPG, 1 x (4 x 0.06 mm <sup>2</sup> ) + 4 x 0.06 mm <sup>2</sup> with TPE wires, 2 x 0.16 mm <sup>2</sup> for temperature sensor; 15-pin PCB connector and 6-pin contact insert for hybrid connecting element (male) 	0.15 m	0.06 mm <sup>2</sup>	EnDat22
1036361-xx	<b>APK</b> Ø 6 mm, 2 x (2 x 0.09 mm <sup>2</sup> ) + 2 x (2 x 0.16 mm <sup>2</sup> ); 12-pin M12 quick connector and 8-pin M12 coupling (male) 	1 m to 20 m	2 x 0.16 mm <sup>2</sup>	EnDat22 Fanuc... Mit... Pana... YEC...
1036372-xx	<b>VBK</b> Ø 6 mm, 2 x (2 x 0.09 mm <sup>2</sup> ) + 2 x (2 x 0.16 mm <sup>2</sup> ); 8-pin M12 connector (female) and 8-pin M12 coupling (male) 	1 m to 30 m	2 x 0.16 mm <sup>2</sup>	EnDat22 Fanuc... Mit... Pana... YEC...
1036380-xx	<b>VBK</b> Ø 8 mm, 2 x (2 x 0.24 mm <sup>2</sup> ) + 2 x (2 x 0.35 mm <sup>2</sup> ); 8-pin M12 right-angle connector (female) and 8-pin M12 coupling (male) 	1 m to 50 m	2 x 0.35 mm <sup>2</sup>	EnDat22 Fanuc... Mit... Pana... YEC...
1036386-xx	<b>VBK</b> Ø 6 mm, 2 x (2 x 0.09 mm <sup>2</sup> ) + 2 x (2 x 0.16 mm <sup>2</sup> ); 8-pin M12 right-angle connector (female) and 8-pin M12 coupling (male) 	1 m to 30 m	2 x 0.16 mm <sup>2</sup>	EnDat22 Fanuc... Mit... Pana... YEC...
1036521-xx	<b>APK</b> Ø 6 mm, 2 x (2 x 0.09 mm <sup>2</sup> ) + 2 x (2 x 0.16 mm <sup>2</sup> ); 8-pin M12 connector (female) and 15-pin D-sub connector (female) 	1 m to 50 m	2 x 0.16 mm <sup>2</sup>	EnDat22

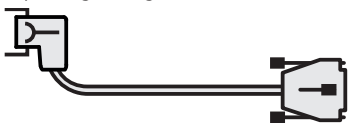







ID		Length	Ap	Use with
1036526-xx	<b>APK</b> Ø 6 mm, 2 x (2 x 0.09 mm <sup>2</sup> ) + 2 x (2 x 0.16 mm <sup>2</sup> ); 8-pin M12 connector (female) and 15-pin D-sub connector (male) 	1 m to 30 m	2 x 0.16 mm <sup>2</sup>	EnDat22 Fanuc... Mit... Pana... YEC...
1036537-xx	<b>APK</b> Ø 4.5 mm, 1 x (4 x 0.09 mm <sup>2</sup> ) + 4 x 0.16 mm <sup>2</sup> ; 14-pin M12 coupling and 8-pin M12 coupling (male) 	1 m to 20 m	2 x 0.16 mm <sup>2</sup>	EnDat22 Fanuc... Mit... Pana... YEC...
1036547-xx	<b>APK</b> Ø 6 mm, 2 x (2 x 0.09 mm <sup>2</sup> ) + 2 x (2 x 0.16 mm <sup>2</sup> ); 14-pin M12 coupling and 8-pin M12 coupling (male) 	1 m to 20 m	2 x 0.16 mm <sup>2</sup>	EnDat22 Fanuc... Mit... Pana... YEC...
1036549-xx	<b>APK</b> Ø 4.5 mm, 1 x (4 x 0.09 mm <sup>2</sup> ) + 4 x 0.16 mm <sup>2</sup> or 4 x (2 x 0.16 mm <sup>2</sup> ); 14-pin M12 coupling and 17-pin M23 coupling (male) 	1 m to 9 m	2 x 0.16 mm <sup>2</sup>	EnDat22 Fanuc... Mit... Pana... YEC...
1036555-xx	<b>APK</b> Ø 6 mm, 2 x (2 x 0.09 mm <sup>2</sup> ) + 2 x (2 x 0.16 mm <sup>2</sup> ); 14-pin M12 coupling and 17-pin M23 coupling (male) 	1 m to 9 m	2 x 0.16 mm <sup>2</sup>	EnDat22 Fanuc... Mit... Pana... YEC...
1036724-xx	<b>APK</b> Ø 4.5 mm, 1 x (4 x 0.09 mm <sup>2</sup> ) + 4 x 0.16 mm <sup>2</sup> or 4 x (2 x 0.16 mm <sup>2</sup> ); 14-pin M12 coupling and 15-pin Mini Delta Ribbon connector (female) 	1 m to 30 m	2 x 0.16 mm <sup>2</sup>	Fanuc...
1036726-xx	<b>APK</b> Ø 6 mm, 2 x (2 x 0.09 mm <sup>2</sup> ) + 2 x (2 x 0.16 mm <sup>2</sup> ); 14-pin M12 coupling and 15-pin Mini Delta Ribbon connector (female) 	1 m to 30 m	2 x 0.16 mm <sup>2</sup>	Fanuc...
1036736-xx	<b>APK</b> Ø 4.5 mm, 1 x (4 x 0.09 mm <sup>2</sup> ) + 4 x 0.16 mm <sup>2</sup> ; 14-pin M12 coupling and 20-pin Mini Delta Ribbon connector (male) 	1 m to 30 m	2 x 0.16 mm <sup>2</sup>	Mit...
1036737-xx	<b>APK</b> Ø 6 mm, 2 x (2 x 0.09 mm <sup>2</sup> ) + 2 x (2 x 0.16 mm <sup>2</sup> ); 14-pin M12 coupling and 20-pin Mini Delta Ribbon connector (male) 	1 m to 30 m	2 x 0.16 mm <sup>2</sup>	Mit...
1036775-xx	<b>APK</b> Ø 4.5 mm, 1 x (4 x 0.09 mm <sup>2</sup> ) + 4 x 0.16 mm <sup>2</sup> ; 14-pin M12 coupling and 10-pin Mini Delta Ribbon connector (male) 	1 m to 30 m	2 x 0.16 mm <sup>2</sup>	Mit...
1036781-xx	<b>APK</b> Ø 6 mm, 2 x (2 x 0.09 mm <sup>2</sup> ) + 2 x (2 x 0.16 mm <sup>2</sup> ); 14-pin M12 coupling and 10-pin Mini Delta Ribbon connector (male) 	1 m to 30 m	2 x 0.16 mm <sup>2</sup>	Mit...











ID		Length	A <sub>P</sub>	Use with
1036785-xx	<b>APK</b> Ø 4.5 mm, 1 x (4 x 0.09 mm <sup>2</sup> ) + 4 x 0.16 mm <sup>2</sup> ; 14-pin M12 coupling and 15-pin D-sub connector (female) 	1 m to 30 m	2 x 0.16 mm <sup>2</sup>	EnDat22
1036814-xx	<b>APK</b> Ø 6 mm, 2 x (2 x 0.09 mm <sup>2</sup> ) + 2 x (2 x 0.16 mm <sup>2</sup> ); 14-pin M12 coupling and 15-pin D-sub connector (female) 	1 m to 30 m	2 x 0.16 mm <sup>2</sup>	EnDat22
1070793-xx	<b>APK</b> Ø 6 mm, 1 x (4 x 0.16 mm <sup>2</sup> ) + 4 x 0.34 mm <sup>2</sup> ; 8-pin M12 connector (female) and 9-pin D-sub connector (male) (TNC X13) 	1 m to 30 m	0.34 mm <sup>2</sup>	TS/TT
1070794-xx	<b>APK</b> Ø 6 mm, 1 x (4 x 0.16 mm <sup>2</sup> ) + 4 x 0.34 mm <sup>2</sup> ; 8-pin M12 connector (female) and 15-pin, 3-row D-sub connector (male) (PLB X113) 	1 m to 30 m	0.34 mm <sup>2</sup>	TS/TT
1070795-xx	<b>APK</b> Ø 6 mm, 1 x (4 x 0.16 mm <sup>2</sup> ) + 4 x 0.34 mm <sup>2</sup> ; 8-pin M12 connector (female) and 15-pin, 3-row D-sub connector (male) (PLB X112) 	1 m to 30 m	0.34 mm <sup>2</sup>	TS/TT
1072523-xx	<b>APK</b> Ø 6 mm, 6 x (2 x 0.19 mm <sup>2</sup> ); 12-pin M12 quick connector and 17-pin M23 coupling (male) with flange 	0.5 m to 3 m	2 x 0.19 mm <sup>2</sup>	EnDat02
1072652-02	<b>AGK HMC 6 ECI 119/ECI/EQI 11xx</b> , Ø 3.7 mm EPG (cable clamp mounted onto crimp sleeve), 1 x (4 x 0.06 mm <sup>2</sup> ) + 4 x 0.06 mm <sup>2</sup> with TPE wires, 2 x 0.16 mm <sup>2</sup> for temperature sensor; 15-pin PCB connector and 6-pin contact insert for hybrid connecting element (male) 	0.2 m	0.06 mm <sup>2</sup>	EnDat22
1073372-xx	<b>VBK</b> Ø 8 mm, 4 x (2 x 0.16 mm <sup>2</sup> ) + 4 x 0.5 mm <sup>2</sup> ; 15-pin, 3-row D-sub connector without locking screws (female) and 15-pin, 3-row D-sub connector (male) 	0.5 m to 20 m	0.5 mm <sup>2</sup>	TS/TT
1080050-xx	<b>VBK</b> Ø 6 mm, 2 x (2 x 0.09 mm <sup>2</sup> ) + 2 x (2 x 0.16 mm <sup>2</sup> ); 12-pin M12 quick connector and unstripped cable end 	1 m to 20 m	2 x 0.16 mm <sup>2</sup>	EnDat22 Fanuc... Mit... Pana... YEC...
1080091-xx	<b>VBK</b> Ø 6 mm, 2 x (2 x 0.09 mm <sup>2</sup> ) + 2 x (2 x 0.16 mm <sup>2</sup> ); 15-pin D-sub connector without locking screws (female) and 15-pin D-sub connector (male); testing cable for PWM 21/PWT 100 	1 m to 15 m	2 x 0.16 mm <sup>2</sup>	EnDat21 EnDat22









ID		Length	Ap	Use with
1083190-xx	<b>VBK</b> Ø 10 mm, 1 x (4 x 0.16 mm <sup>2</sup> ) + 4 x 0.34 mm <sup>2</sup> , partially with heat-shrink tubing; 8-pin M12 connector (female) and stripped cable end 	1 m to 50 m	0.34 mm <sup>2</sup>	TS/TT
1083369-xx	<b>APK</b> Ø 6 mm, 2 x (2 x 0.09 mm <sup>2</sup> ) + 2 x (2 x 0.16 mm <sup>2</sup> ); 14-pin M12 coupling and 25-pin D-sub connector (female) 	1 m to 30 m	2 x 0.16 mm <sup>2</sup>	EnDat22
1085542-xx	<b>VBK, suitable for vacuum</b> ; 15-pin D-sub connector (female) and 15-pin D-sub connector (female) 	0.5 m to 10 m	2 x 0.05 mm <sup>2</sup>	1 V <sub>PP</sub>
1093042-xx	<b>APK</b> Ø 6.8 mm, green, 2 x (2 x 0.17 mm <sup>2</sup> ) + 1 x (2 x 0.24 mm <sup>2</sup> ); 8-pin M12 connector (female) and RJ45 connector 	1 m to 30 m	0.24 mm <sup>2</sup>	DQ...
1094652-xx	<b>APK</b> Ø 6.8 mm, green, 2 x (2 x 0.17 mm <sup>2</sup> ) + 1 x (2 x 0.24 mm <sup>2</sup> ); 8-pin M12 connector (female) and RJ45 connector (IP67) 	1 m to 30 m	0.24 mm <sup>2</sup>	DQ...
1095709-xx	<b>APK</b> Ø 4.5 mm; (Renishaw touch probe connected to QUADRA-CHEK 3000, GAGE-CHEK 2000); 5-pin DIN coupling (female) and 15-pin D-sub connector (male) 	0.5 m to 20 m	0.14 mm <sup>2</sup>	QUADRA-CHEK
1099975-xx	<b>VBK</b> Ø 10 mm, 1 x (4 x 0.16 mm <sup>2</sup> ) + 4 x 0.34 mm <sup>2</sup> ; 8-pin M12 connector (female) and 7-pin M23 connector (male) 	1 m to 50 m	0.34 mm <sup>2</sup>	TS/TT
1100199-N3	<b>AGK ECN 1325/EQN 1337/ECI 1319/EQI 1331</b> TPE single wires with braided sleeve (with shield crimp Ø 6.1 mm), 8 x 0.16 mm <sup>2</sup> ; 12-pin PCB connector and stripped cable end 	0.3 m	2 x 0.16 mm <sup>2</sup>	EnDat22
1108076-01	<b>AGK ECN 1325/EQN 1337/ECI 1319/EQI 1331</b> Ø 3.7 mm EPG (with shield crimp Ø 6.1 mm), 1 x (4 x 0.06 mm <sup>2</sup> ) + 4 x 0.06 mm <sup>2</sup> and TPE wires, 2 x 0.16 mm <sup>2</sup> for temperature sensor; 16-pin PCB connector (12+4) and unstripped cable end 	0.3 m	2 x 0.06 mm <sup>2</sup>	EnDat22
1108078-01	<b>AGK ECN 1123/EQN 1135</b> Ø 3.7 mm EPG (with shield crimp Ø 4.3 mm), 1 x (4 x 0.06 mm <sup>2</sup> ) + 4 x 0.06 mm <sup>2</sup> and TPE wires, 2 x 0.16 mm <sup>2</sup> for temperature sensor; 15-pin PCB connector and unstripped cable end 	0.3 m	2 x 0.06 mm <sup>2</sup>	EnDat22
1109993-xx	<b>VBK</b> Ø 10 mm, 6 x (2 x 0.19 mm <sup>2</sup> ); 12-pin M12 connector (female) and 12-pin M12 coupling (male) 	1 m to 20 m	0.19 mm <sup>2</sup>	1 V <sub>PP</sub> TS/TT





ID		Length	A <sub>P</sub>	Use with
1113288-01	<b>APK</b> , 1 x 1 V <sub>PP</sub> with 15-pin D-sub connector (female) 	1 m	2 x 0.19 mm <sup>2</sup>	IK
1113288-02	<b>APK</b> , 1 x TTL with 9-pin D-sub connector (female) 	1 m	0.19 mm <sup>2</sup>	IK
1113289-01	<b>APK</b> , 2 x 1 V <sub>PP</sub> with 15-pin D-sub connector (female) and 3-pin Mini DIN connector (female) for foot pedal 	1 m	2 x 0.19 mm <sup>2</sup>	IK
1113289-02	<b>APK</b> , 2 x TTL with 9-pin D-sub connector (female) and 3-pin Mini DIN connector (female) for foot pedal 	1 m	0.19 mm <sup>2</sup>	IK
1116479-03	<b>AGK ECI 119/EBI 135</b> , Ø 3.7 mm EPG (cable clamp mounted onto crimp sleeve), 1 x (4 x 0.06 mm <sup>2</sup> ) + 4 x 0.06 mm <sup>2</sup> and TPE wires, 2 x 0.16 mm <sup>2</sup> for temperature sensor; 15-pin PCB connector and unstripped cable end 	0.3 m	2 x 0.06 mm <sup>2</sup>	EnDat22
1117280-01	<b>AGK ECN 1325/EQN 1337/ECI 1319/EQI 1331</b> , TPE single wires with braided sleeve (with shield crimp Ø 6.1 mm), 8 x 0.16 mm <sup>2</sup> and TPE wires, 2 x 0.16 mm <sup>2</sup> for temperature sensor; 16-pin (12+4) PCB connector and 8-pin M12 flange socket (male), without shield 	0.3 m	2 x 0.16 mm <sup>2</sup>	EnDat22
1117412-01 1117412-03	<b>AGK ECN 1123/EQN 1135</b> , TPE single wires with braided sleeve (with shield crimp Ø 4.3 mm), 8 x 0.16 mm <sup>2</sup> and TPE wires, 2 x 0.16 mm <sup>2</sup> for temperature sensor; 15-pin PCB connector and 8-pin M12 flange socket (male), without shield 	0.15 m 0.11 m	2 x 0.16 mm <sup>2</sup>	EnDat22
1117540-xx	<b>APK</b> Ø 6.8 mm, green, 2 x (2 x 0.17 mm <sup>2</sup> ) + 1 x (2 x 0.24 mm <sup>2</sup> ); 9-pin M23 connector (female) and RJ45 connector (IP20) 	1 m to 30 m	0.24 mm <sup>2</sup>	DQ...
1118858-xx	<b>VBK</b> Ø 3.7 mm, 1 x (4 x 0.06 mm <sup>2</sup> ) + 4 x 0.06 mm <sup>2</sup> ; 8-pin M12 connector (female) and 8-pin M12 coupling (male) 	1 m to 6 m	2 x 0.06 mm <sup>2</sup>	EnDat22 Fanuc... Mit... Pana... YEC...



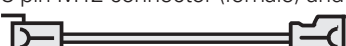
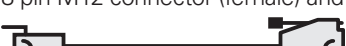
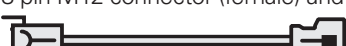



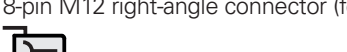
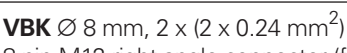

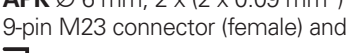
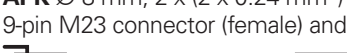
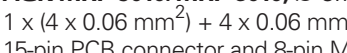

ID		Length	Ap	Use with
1118863-xx	<b>VBK</b> Ø 3,7 mm, 1 x (4 x 0.06 mm <sup>2</sup> ) + 4 x 0.06 mm <sup>2</sup> ; 8-pin M12 right-angle connector (female) and 8-pin M12 coupling (male) 	1 m to 6 m	2 x 0.06 mm <sup>2</sup>	EnDat22 Fanuc... Mit... Pana... YEC...
1118865-xx	<b>APK</b> Ø 3.7 mm, 1 x (4 x 0.06 mm <sup>2</sup> ) + 4 x 0.06 mm <sup>2</sup> ; 8-pin M12 connector (female) and 15-pin D-sub connector (male) 	1 m to 6 m	2 x 0.06 mm <sup>2</sup>	EnDat22 Fanuc... Mit... Pana... YEC...
1118867-xx	<b>APK</b> Ø 3.7 mm, 1 x (4 x 0.06 mm <sup>2</sup> ) + 4 x 0.06 mm <sup>2</sup> ; 8-pin, right-angle M12 connector (female) and 15-pin D-sub connector (male) 	1 m to 6 m	2 x 0.06 mm <sup>2</sup>	EnDat22 Fanuc... Mit... Pana... YEC...
1118892-02	<b>AGK ERN 1387</b> , PUR Ø 4.5 mm, 16 x 0.057 mm <sup>2</sup> ; 14-pin PCB connector with strain relief and 15-pin D-sub connector (male), including three 14-pin adapter connectors; testing cable for PWM 21 	2 m	2 x 0.057 mm <sup>2</sup>	1 V <sub>pp</sub> + Z1
1119209-xx	<b>APK</b> Ø 4.5 mm, 1 x (4 x 0.09 mm <sup>2</sup> ) + 4 x 0.16 mm <sup>2</sup> ; 12-pin M12 connecting element and 17-pin M23 coupling (male) 	0.5 m to 9 m	2 x 0.16 mm <sup>2</sup>	Fanuc... Mit...
1119352-xx	<b>APK</b> Ø 4.5 mm, 1 x (4 x 0.09 mm <sup>2</sup> ) + 4 x 0.16 mm <sup>2</sup> ; 12-pin M12 connecting element and 15-pin D-sub connector (male) 	1 m to 30 m	2 x 0.16 mm <sup>2</sup>	EnDat22
1119394-xx	<b>APK</b> Ø 4.5 mm, 1 x (4 x 0.09 mm <sup>2</sup> ) + 4 x 0.16 mm <sup>2</sup> ; 12-pin M12 quick connector and 15-pin D-sub connector (female) 	1 m to 30 m	2 x 0.16 mm <sup>2</sup>	EnDat22
1119910-xx	<b>APK</b> Ø 4.5 mm, 1 x (4 x 0.09 mm <sup>2</sup> ) + 4 x 0.16 mm <sup>2</sup> ; 12-pin M12 connecting element and 25-pin D-sub connector (female) 	1 m to 30 m	2 x 0.16 mm <sup>2</sup>	EnDat22
1119918-xx	<b>APK</b> Ø 4.5 mm, 1 x (4 x 0.09 mm <sup>2</sup> ) + 4 x 0.16 mm <sup>2</sup> ; 12-pin M12 quick connector and 15-pin Mini Delta Ribbon connector (female) 	1 m to 30 m	2 x 0.16 mm <sup>2</sup>	Fanuc...
1119920-xx	<b>APK</b> Ø 4.5 mm, 1 x (4 x 0.09 mm <sup>2</sup> ) + 4 x 0.16 mm <sup>2</sup> ; 12-pin M12 quick connector and 20-pin Mini Delta Ribbon connector (male) 	1 m to 30 m	2 x 0.16 mm <sup>2</sup>	Mit...
1119925-xx	<b>APK</b> Ø 4.5 mm, 1 x (4 x 0.09 mm <sup>2</sup> ) + 4 x 0.16 mm <sup>2</sup> ; 12-pin M12 quick connector and 10-pin Mini Delta Ribbon connector (female) 	1 m to 30 m	2 x 0.16 mm <sup>2</sup>	Mit...









ID		Length	A <sub>p</sub>	Use with
1119952-15	<b>AGK ECI 1119/EQI 1131</b> , TPE single wires with braided sleeve, 8 x 0.16 mm <sup>2</sup> and TPE wires, 2 x 0.16 mm <sup>2</sup> for temperature sensor; 15-pin PCB connector and 8-pin M12 straight flange socket (male), without shield 	0.15 m	2 x 0.16 mm <sup>2</sup>	EnDat22
1119958-15	<b>AGK ECI 1119/EQI 1131</b> , TPE single wires with braided sleeve, 8 x 0.16 mm <sup>2</sup> and TPE wires, 2 x 0.16 mm <sup>2</sup> for temperature sensor; 15-pin PCB connector and stripped cable end without shield 	0.15 m	2 x 0.16 mm <sup>2</sup>	EnDat22
1120664-xx	<b>VBK</b> Ø 4.5 mm, 1 x (4 x 0.09 mm <sup>2</sup> ) + 4 x 0.16 mm <sup>2</sup> ; 12-pin M12 quick connector and unstripped cable end 	1 m to 20 m	2 x 0.16 mm <sup>2</sup>	EnDat22 Fanuc... Mit... Pana... YEC...
1120686-xx	<b>APK</b> Ø 6 mm, 2 x (2 x 0.09 mm <sup>2</sup> ) + 2 x (2 x 0.16 mm <sup>2</sup> ); 15-pin D-sub connector (female) and 8-pin M12 coupling (male) 	1 m to 30 m	2 x 0.16 mm <sup>2</sup>	EnDat22 Fanuc... Mit... Pana... YEC...
1120940-30 1120940-01	<b>AGK ECI 4010/EBI 4010</b> , Ø 3.7 mm EPG (with shield crimp Ø 4.3 mm), 1 x (4 x 0.06 mm <sup>2</sup> ) + 4 x 0.06 mm <sup>2</sup> and TPE wires, 2 x 0.16 mm <sup>2</sup> for temperature sensor; 15-pin PCB connector and 9-pin M23 SpeedTEC angle flange socket (male) 	0.3 m 1 m	2 x 0.06 mm <sup>2</sup>	EnDat22
1120945-15 1120945-30	<b>AGK ECN 1324S/EQN 1336S</b> , Ø 3.7 mm EPG (with shield crimp Ø 6.1 mm), 2 x (2 x 0.06 mm <sup>2</sup> ) + 4 x 0.06 mm <sup>2</sup> and TPE wires, 2 x 0.16 mm <sup>2</sup> for temperature sensor; 16-pin (12+4) PCB connector and 9-pin M23 SpeedTEC angle flange socket (male) 	0.15 m 0.3 m	2 x 0.06 mm <sup>2</sup>	DQ...
1120947-03	<b>AGK ECI 119/EBI 135</b> , Ø 3.7 mm EPG (cable clamp mounted onto crimp sleeve), 1 x (4 x 0.06 mm <sup>2</sup> ) + 4 x 0.06 mm <sup>2</sup> and TPE wires, 2 x 0.16 mm <sup>2</sup> for temperature sensor; 15-pin PCB connector and 9-pin M23 SpeedTEC angle flange socket (male) 	0.3 m	2 x 0.06 mm <sup>2</sup>	EnDat22
1120948-01	<b>AGK ECN 1325/EQN 1337/ECI 1319/EQI 1331</b> , Ø 3.7 mm EPG (with shield crimp Ø 6.1 mm) 1 x (4 x 0.06 mm <sup>2</sup> ) + 4 x 0.06 mm <sup>2</sup> and TPE wires 2 x 0.16 mm <sup>2</sup> for temperature sensor; 16-pin (12+4) PCB connector and 9-pin M23 SpeedTEC angle flange socket (male) 	0.3 m	2 x 0.06 mm <sup>2</sup>	EnDat22
1121041-03 1121041-01	<b>AGK ECI 4010/EBI 4010</b> , Ø 3.7 mm EPG (with shield crimp Ø 4.3 mm), 1 x (4 x 0.06 mm <sup>2</sup> ) + 4 x 0.06 mm <sup>2</sup> ; 15-pin PCB connector and 9-pin M23 SpeedTEC angle flange socket (male) 	0.3 m 1 m	2 x 0.06 mm <sup>2</sup>	EnDat22







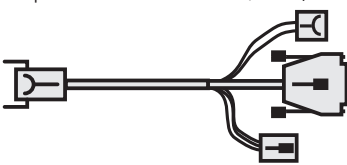

ID		Length	Ap	Use with
1121536-xx	<b>APK</b> Ø 6.8 mm, green, 2 x (2 x 0.17 mm <sup>2</sup> ) + 1 x (2 x 0.24 mm <sup>2</sup> ); 9-pin M23 SpeedTEC connector (female) and 8-pin M12 coupling (male) 	1 m to 30 m	0.24 mm <sup>2</sup>	DQ...
1121546-xx	<b>APK</b> Ø 6.8 mm, green, 2 x (2 x 0.17 mm <sup>2</sup> ) + 1 x (2 x 0.24 mm <sup>2</sup> ); 9-pin M23 SpeedTEC connector (female) and RJ45 connector (IP20) 	1 m to 30 m	0.24 mm <sup>2</sup>	DQ...
1121591-xx	<b>APK</b> PUR Ø 6.8 mm, green, 2 x (2 x 0.17 mm <sup>2</sup> ) + 1 x (2 x 0.24 mm <sup>2</sup> ); 6-pin RJ45 connector (male) with metal housing (IP67) and 8-pin M12 coupling (male) 	20 m	0.24 mm <sup>2</sup>	DQ...
1122879-xx	<b>APK</b> Ø 10 mm, 1 x (4 x 0.09 mm <sup>2</sup> ) + 4 x 0.16 mm <sup>2</sup> ; 14-pin M12 coupling and 8-pin M12 coupling (male) 	1 m to 20 m	2 x 0.16 mm <sup>2</sup>	EnDat22 Fanuc... Mit... Pana... YEC...
1122889-xx	<b>VBK</b> Ø 4.5 mm, 1 x (4 x 0.09 mm <sup>2</sup> ) + 4 x 0.16 mm <sup>2</sup> ; 14-pin M12 coupling and stripped cable end 	1 m to 20 m	2 x 0.16 mm <sup>2</sup>	EnDat22 Fanuc... Mit... Pana... YEC...
1123096-xx	<b>APK</b> Ø 10 mm, 1 x (4 x 0.09 mm <sup>2</sup> ) + 4 x 0.16 mm <sup>2</sup> ; 14-pin M12 coupling and 15-pin D-sub connector (male) 	1 m to 30 m	2 x 0.16 mm <sup>2</sup>	EnDat22 Pana...
1123108-xx	<b>APK</b> Ø 10 mm, 1 x (4 x 0.09 mm <sup>2</sup> ) + 4 x 0.16 mm <sup>2</sup> ; 14-pin M12 coupling and 15-pin D-sub connector (female) 	1 m to 30 m	2 x 0.16 mm <sup>2</sup>	EnDat22
1125403-N3	<b>AGK ECI 4090S</b> , Ø 3.7 mm EPG (with shield crimp Ø 4.3 mm), 2 x (2 x 0.06 mm <sup>2</sup> ) + 4 x 0.06 mm <sup>2</sup> and TPE wires, 2 x 0.16 mm <sup>2</sup> for temperature sensor; 15-pin PCB connector and 9-pin M23 SpeedTEC angle flange socket (male) 	0.3 m	2 x 0.06 mm <sup>2</sup>	DQ...
1125408-N3	<b>AGK ECI 4090S</b> , Ø 3.7 mm EPG (with shield crimp Ø 4.3 mm), 2 x (2 x 0.06 mm <sup>2</sup> ) + 4 x 0.06 mm <sup>2</sup> ; 15-pin PCB connector and 9-pin M23 SpeedTEC angle flange socket (male) 	0.3 m	2 x 0.06 mm <sup>2</sup>	DQ...
1126031-xx	<b>APK</b> Ø 10 mm, 1 x (4 x 0.09 mm <sup>2</sup> ) + 4 x 0.16 mm <sup>2</sup> or 4 x (2 x 0.16 mm <sup>2</sup> ); 14-pin M12 coupling and 15-pin Mini Delta Ribbon connector (female) 	1 m to 30 m	2 x 0.16 mm <sup>2</sup>	Fanuc...
1126035-xx	<b>APK</b> Ø 10 mm, 1 x (4 x 0.09 mm <sup>2</sup> ) + 4 x 0.16 mm <sup>2</sup> or 4 x (2 x 0.16 mm <sup>2</sup> ); 14-pin M12 coupling and 17-pin M23 coupling (male) 	1 m to 9 m	2 x 0.16 mm <sup>2</sup>	EnDat22 Fanuc... Mit... Pana... YEC...







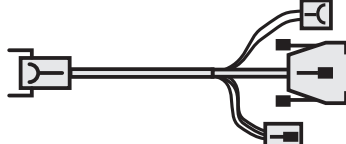

ID		Length	A <sub>p</sub>	Use with
1127794-xx	<b>APK</b> Ø 10 mm, 1 x (4 x 0.09 mm <sup>2</sup> ) + 4 x 0.16 mm <sup>2</sup> ; 14-pin M12 coupling and 20-pin Mini Delta Ribbon connector (male) 	1 m to 30 m	2 x 0.16 mm <sup>2</sup>	Mit...
1127827-xx	<b>APK</b> Ø 10 mm, 1 x (4 x 0.09 mm <sup>2</sup> ) + 4 x 0.16 mm <sup>2</sup> ; 14-pin M12 coupling and 10-pin Mini Delta Ribbon connector (female) 	1 m to 30 m	2 x 0.16 mm <sup>2</sup>	Mit...
1129083-xx	<b>AGK MRP 2010</b> , Ø 3.7 mm (with shield crimp Ø 3.7 mm), 1 x (4 x 0.06 mm <sup>2</sup> ) + 4 x 0.06 mm <sup>2</sup> ; 12-pin PCB connector and 8-pin M12 coupling (male) 	0.3 m 6 m	2 x 0.06 mm <sup>2</sup>	EnDat22
1129581-xx	<b>VBK</b> Ø 6 mm, 2 x (2 x 0.09 mm <sup>2</sup> ) + 2 x (2 x 0.16 mm <sup>2</sup> ); 8-pin M12 connector (female) and unstripped cable end 	1 m to 30 m	2 x 0.16 mm <sup>2</sup>	EnDat22 Fanuc... Mit... Pana... YEC...
1129591-xx	<b>VBK</b> Ø 8 mm, 2 x (2 x 0.24 mm <sup>2</sup> ) + 2 x (2 x 0.35 mm <sup>2</sup> ); 8-pin M12 connector (female) and unstripped cable end 	1 m to 50 m	2 x 0.35 mm <sup>2</sup>	EnDat22 Fanuc... Mit... Pana... YEC...
1129753-xx	<b>APK</b> Ø 8 mm, 2 x (2 x 0.24 mm <sup>2</sup> ) + 2 x (2 x 0.35 mm <sup>2</sup> ); 8-pin M12 connector (female) and 15-pin D-sub connector (male) 	1 m to 50 m	2 x 0.35 mm <sup>2</sup>	EnDat22 Fanuc... Mit... Pana... YEC...
1130829-xx	<b>APK</b> Ø 6 mm, 2 x (2 x 0.09 mm <sup>2</sup> ) + 2 x (2 x 0.16 mm <sup>2</sup> ); 8-pin M12 connector (female) and 17-pin M23 coupling (male) 	1 m to 9 m	2 x 0.16 mm <sup>2</sup>	EnDat22 Fanuc... Mit... Pana... YEC...
1130952-xx	<b>APK</b> Ø 6 mm, 2 x (2 x 0.09 mm <sup>2</sup> ) + 2 x (2 x 0.16 mm <sup>2</sup> ); 8-pin M12 connector (female) and 15-pin Mini Delta Ribbon connector (female) 	1 m to 30 m	2 x 0.16 mm <sup>2</sup>	Fanuc...
1130978-xx	<b>APK</b> Ø 8 mm, 2 x (2 x 0.24 mm <sup>2</sup> ) + 2 x (2 x 0.35 mm <sup>2</sup> ); 8-pin M12 connector (female) and 15-pin Mini Delta Ribbon connector (female) 	1 m to 50 m	2 x 0.35 mm <sup>2</sup>	Fanuc...
1130994-xx	<b>APK</b> Ø 8 mm, 2 x (2 x 0.24 mm <sup>2</sup> ) + 2 x (2 x 0.35 mm <sup>2</sup> ); 8-pin M12 connector (female) and 15-pin D-sub connector (female) 	1 m to 50 m	2 x 0.35 mm <sup>2</sup>	EnDat22
1132594-xx	<b>APK</b> Ø 6 mm, 2 x (2 x 0.09 mm <sup>2</sup> ) + 2 x (2 x 0.16 mm <sup>2</sup> ); 8-pin M12 connector (female) and 20-pin Mini Delta Ribbon connector (male) 	1 m to 30 m	2 x 0.16 mm <sup>2</sup>	Mit...

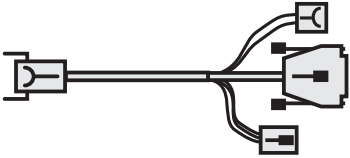
ID		Length	Ap	Use with
1132621-xx	<b>APK</b> Ø 6 mm, 2 x (2 x 0.09 mm <sup>2</sup> ) + 2 x (2 x 0.16 mm <sup>2</sup> ); 8-pin M12 connector (female) and 10-pin Mini Delta Ribbon connector (female) 	1 m to 30 m	2 x 0.16 mm <sup>2</sup>	Mit...
1133104-xx	<b>APK</b> Ø 6 mm, 2 x (2 x 0.09 mm <sup>2</sup> ) + 2 x (2 x 0.16 mm <sup>2</sup> ); 8-pin M12 connector (female) and 25-pin D-sub connector (female) 	1 m to 30 m	2 x 0.16 mm <sup>2</sup>	EnDat22
1133119-xx	<b>APK</b> Ø 8 mm, 2 x (2 x 0.24 mm <sup>2</sup> ) + 2 x (2 x 0.35 mm <sup>2</sup> ); 8-pin M12 connector (female) and 25-pin D-sub connector (female) 	1 m to 50 m	2 x 0.35 mm <sup>2</sup>	EnDat22
1133799-xx	<b>VBK</b> Ø 6 mm, 2 x (2 x 0.09 mm <sup>2</sup> ) + 2 x (2 x 0.16 mm <sup>2</sup> ); 8-pin M12 right-angle connector (female) and unstripped cable end 	1 m to 30 m	2 x 0.16 mm <sup>2</sup>	EnDat22 Fanuc... Mit... Pana... YEC...
1133832-xx	<b>VBK</b> Ø 8 mm, 2 x (2 x 0.24 mm <sup>2</sup> ) + 2 x (2 x 0.35 mm <sup>2</sup> ); 8-pin M12 right-angle connector (female) and unstripped cable end 	1 m to 50 m	2 x 0.35 mm <sup>2</sup>	EnDat22 Fanuc... Mit... Pana... YEC...
1133855-xx	<b>APK</b> Ø 6 mm, 2 x (2 x 0.09 mm <sup>2</sup> ) + 2 x (2 x 0.16 mm <sup>2</sup> ); 8-pin M12 right-angle connector (female) and 15-pin D-sub connector (male) 	1 m to 10 m	2 x 0.16 mm <sup>2</sup>	EnDat22 Fanuc... Mit... Pana... YEC...
1136863-xx	<b>APK</b> Ø 6 mm, 2 x (2 x 0.09 mm <sup>2</sup> ) + 2 x (2 x 0.16 mm <sup>2</sup> ); 9-pin M23 connector (female) and 8-pin M12 coupling (male) 	1 m to 9 m	2 x 0.16 mm <sup>2</sup>	EnDat22
1136874-xx	<b>APK</b> Ø 8 mm, 2 x (2 x 0.24 mm <sup>2</sup> ) + 2 x (2 x 0.35 mm <sup>2</sup> ); 9-pin M23 connector (female) and 8-pin M12 coupling (male) 	1 m to 9 m	2 x 0.35 mm <sup>2</sup>	EnDat22
1137151-xx	<b>AGK MRP 5010/MRP 8010</b> , Ø 3.7 mm (with shield crimp Ø 3.7 mm), 1 x (4 x 0.06 mm <sup>2</sup> ) + 4 x 0.06 mm <sup>2</sup> ; 15-pin PCB connector and 8-pin M12 coupling (male) 	0.3 m to 6 m	2 x 0.06 mm <sup>2</sup>	EnDat22
1139183-xx	<b>VBK PUR</b> Ø 6 mm, 2 x (2 x 0.09 mm <sup>2</sup> ) + 2 x (2 x 0.16 mm <sup>2</sup> ); 15-pin, 2-row D-sub connector (female) with locking screw and 15-pin D-sub connector (male) 	0.5 m to 30 m	2 x 0.16 mm <sup>2</sup>	EnDat22

ID		Length	A <sub>P</sub>	Use with
1143830-30	<b>AGK ECN 1325/EQN 1337/ECI 1319/EQI 1331</b> , TPE single wires with braided sleeve, 8 x 0.16 mm <sup>2</sup> and TPE wires, 2 x 0.16 mm <sup>2</sup> for temperature sensor; 16-pin (12+4) and stripped cable end, without shield 	0.3 m	2 x 0.16 mm <sup>2</sup>	EnDat22
1156708-xx	<b>APK VS 101</b> , PUR Ø 6.8 mm, 4 x (2 x 0.17 mm <sup>2</sup> ); 8-pin M12 connector (female) and 8-pin RJ45 connector 	15 m 20 m	–	VS 101
1158342-xx	<b>APK</b> Ø 4.5 mm, 1 x (4 x 0.09 mm <sup>2</sup> ) + 4 x 0.16 mm <sup>2</sup> ; 14-pin M12 coupling and 15-pin D-sub connector (male) 	1 m to 30 m	2 x 0.16 mm <sup>2</sup>	EnDat22 Pana...
1159446-xx	<b>APK</b> Ø 6 mm; for connection to AccurET position controller; 15-pin, 2-row D-sub connector (female) and 15-pin, 3-row D-sub connector (male) with locking screws 	1 m to 20 m	2 x 0.19 mm <sup>2</sup>	1 V <sub>PP</sub>
1160261-xx	<b>APK</b> Ø 6 mm, 2 x (2 x 0.09 mm <sup>2</sup> ) + 2 x (2 x 0.16 mm <sup>2</sup> ); 14-pin M12 coupling and 10-pin MUF connector (female) 	1 m to 30 m	2 x 0.16 mm <sup>2</sup>	Pana...
1160268-xx	<b>APK</b> Ø 6 mm, 2 x (2 x 0.09 mm <sup>2</sup> ) + 2 x (2 x 0.16 mm <sup>2</sup> ); 8-pin M12 connector (female) and 10-pin MUF connector (female) 	1 m to 30 m	2 x 0.16 mm <sup>2</sup>	Pana...
1160480-xx	<b>AGK MRP 2080</b> , Ø 3.7 mm (with shield crimp Ø 3.7 mm), 6 x (6 x 0.05 mm <sup>2</sup> ); 14-pin PCB connector and 15-pin D-sub connector (male) 	0.3 m to 6 m	2 x 0.05 mm <sup>2</sup>	1 V <sub>PP</sub>
1160559-01	<b>AGK ECI 4090S</b> , Ø 3.7 mm EPG (with shield crimp Ø 4.3 mm), 2 x (2 x 0.06 mm <sup>2</sup> ) + 4 x 0.06 mm <sup>2</sup> ; 15-pin PCB connector and 8-pin M12 coupling (male) 	1 m	2 x 0.06 mm <sup>2</sup>	DQ...
1165032-xx	<b>APK</b> Ø 6 mm; for connection to AccurET position controller; 8-pin M12 connector (female) and 15-pin, 3-row D-sub connector (male) with locking screws 	1 m to 20 m	2 x 0.14 mm <sup>2</sup>	EnDat22
1173166-xx	<b>APK</b> PUR Ø 6 mm, 2 x (2 x 0.09 mm <sup>2</sup> ) + 2 x (2 x 0.16 mm <sup>2</sup> ); 9-pin M23 connector (female) and 15-pin, 2-row D-sub connector (male) with locking screws 	9 m	2 x 0.16 mm <sup>2</sup>	EnDat22
1180354-03	<b>VBK</b> , spiral cable, 4 x 0.14; 8-pin M12 connector (female) and unstripped cable end 	3 m	0.14 mm <sup>2</sup>	TS/TT

ID		Length	Ap	Use with
1180955-xx	<b>AGK AEF 1323</b> , Ø 4.5 mm PUR (with shield crimp Ø 6.1 mm), 3 x 2 x 0.19 mm <sup>2</sup> and TPE wires, 2 x 0.16 mm <sup>2</sup> for temperature sensor; 16-pin (12+4) PCB connector and unstripped cable end 	6 m 10 m 15 m	2 x 0.19 mm <sup>2</sup>	EnDat22
1180959-xx	<b>AGK AEF 1323</b> , Ø 4.5 mm PUR (with shield crimp Ø 6.1 mm), 3 x 2 x 0.19 mm <sup>2</sup> ; 12-pin PCB connector and unstripped cable end 	6 m 10 m 15 m	2 x 0.19 mm <sup>2</sup>	EnDat22
1181373-15 1181373-30	<b>AGK ECN 1324S/EQN 1336S</b> , Ø 3.7 mm; EPG, (with shield crimp Ø 6.1 mm), 2 x (2 x 0.06 mm <sup>2</sup> ) + 4 x 0.06 mm <sup>2</sup> and TPE wires, 2 x 0.16 mm <sup>2</sup> for temperature sensor; 16-pin (12+4) PCB connector and 8-pin M12 flange socket (male) 	0.15 m 0.3 m	0.06 mm <sup>2</sup>	DQ...
1183206-xx	<b>VBK</b> Ø 6 mm, 6 x (2 x 0.19 mm <sup>2</sup> ); 15-pin, 3-row D-sub connector (female) and 15-pin, 3-row D-sub connector (male) 	1 m to 10 m	0.19 mm <sup>2</sup>	TS/TT
1188098-xx	<b>VBK HMC 6</b> PUR hybrid cable Ø 13.6 mm, 1.5 mm <sup>2</sup> power wires with outer shield, orange (2 x 2 x 0.09 mm <sup>2</sup> + 2 x 0.24 mm <sup>2</sup> ) + 1 x (2 x 1.0 mm <sup>2</sup> + 1 x 1.5 mm <sup>2</sup> ) + 1 x (3 x 1.5 mm <sup>2</sup> ); 13-pin M23 SpeedTEC straight connector (female) and unstripped cable end 	10 m 25 m 50 m	0.24 mm <sup>2</sup>	EnDat22
1188099-xx	<b>VBK HMC 6</b> PUR hybrid cable Ø 16.6 mm, 4 mm <sup>2</sup> power wires with outer shield, orange (2 x 2 x 0.09 mm <sup>2</sup> + 2 x 0.24 mm <sup>2</sup> ) + 1 x (2 x 1.0 mm <sup>2</sup> + 1 x 4 mm <sup>2</sup> ) + 1 x (3 x 4 mm <sup>2</sup> ); 13-pin M23 SpeedTEC straight connector (female) and unstripped cable end 	10 m 25 m 50 m	0.24 mm <sup>2</sup>	EnDat22
1189174-01	<b>APK HMC 6</b> PUR hybrid cable Ø 13.6 mm, 1.5 mm <sup>2</sup> power wires with outer shield, orange (2 x 2 x 0.09 mm <sup>2</sup> + 2 x 0.24 mm <sup>2</sup> ) + 1 x (2 x 1.0 mm <sup>2</sup> + 1 x 1.5 mm <sup>2</sup> ) + 1 x (3 x 1.5 mm <sup>2</sup> ); 13-pin M23 SpeedTEC straight connector (female) and 3-pin female header (power); 4-pin male header (brake); 15-pin D-sub connector (male, for communication); testing cable for PWM 21 	1 m	0.24 mm <sup>2</sup>	EnDat22
1217143-15	<b>AGK</b> EPG Ø 3.7 mm (with shield crimp Ø 4.3 mm); 2 x (2 x 0.06 mm <sup>2</sup> ) + 4 x 0.06 mm <sup>2</sup> and TPE wires, 2 x 0.16 mm <sup>2</sup> for temperature sensor; 15-pin PCB connector and 8-pin M12 flange socket (male) 	0.15 m	0.06 mm <sup>2</sup>	DQ...
1217425-xx	<b>VBK</b> Ø 6 mm, 6 x (2 x 0.19 mm <sup>2</sup> ); 15-pin, 3-row D-sub connector (female) and stripped cable end 	1 m to 10 m	0.19 mm <sup>2</sup>	TS/TT

ID		Length	A <sub>P</sub>	Use with
1228399-01	<p><b>APK</b> PUR Ø 6.8 mm, 2 x (2 x 0.17 mm<sup>2</sup>) + 1 x (2 x 0.24 mm<sup>2</sup>), green; 15-pin, 2-row D-sub connector (female) with metal housing (without locking screws) and RJ45 connector (IP20)</p> 	1 m	0.24 mm <sup>2</sup>	DQ...
1235648-xx	<p><b>APK</b> PUR Ø 6 mm, 2 x (2 x 0.09 mm<sup>2</sup>) + 2 x (2 x 0.16 mm<sup>2</sup>), 9-pin M23 connector (female) and 25-pin, 2-row D-sub connector (female) with locking screws</p> 	1 m to 15 m	2 x 0.16 mm <sup>2</sup>	EnDat22
1245572-xx	<p><b>APK</b> PUR Ø 6 mm, 2 x (2 x 0.09 mm<sup>2</sup>) + 2 x (2 x 0.16 mm<sup>2</sup>); 14-pin M12 coupling and 8-pin Type II Mini I/O connector (female)</p> 	1 m to 50 m	2 x 0.16 mm <sup>2</sup>	EnDat22
1245592-xx	<p><b>APK</b> PUR Ø 4.5 mm, 1 x (4 x 0.09 mm<sup>2</sup>) + 4 x 0.16 mm<sup>2</sup>; 14-pin M12 coupling and 8-pin Type II Mini I/O connector (female)</p> 	1 m to 20 m	2 x 0.16 mm <sup>2</sup>	EnDat22
1245639-xx	<p><b>APK</b> PUR Ø 6 mm, 2 x (2 x 0.09 mm<sup>2</sup>) + 2 x (2 x 0.16 mm<sup>2</sup>); 8-pin M12 connector (female) and 8-pin Type II Mini I/O connector (female)</p> 	1 m to 50 m	2 x 0.16 mm <sup>2</sup>	EnDat22
1245843-xx	<p><b>APK</b> PUR Ø 4.5 mm, 1 x (4 x 0.09 mm<sup>2</sup>) + 4 x 0.16 mm<sup>2</sup>; 12-pin M12 quick connector and 8-pin Type II Mini I/O connector (female)</p> 	1 m to 20 m	2 x 0.16 mm <sup>2</sup>	EnDat22
1264917-A5	<p><b>APK</b> PUR Ø 6 mm, 2 x (2 x 0.09 mm<sup>2</sup>) + 2 x (2 x 0.16 mm<sup>2</sup>); 15-pin D-sub connector (male) and 8-pin Type II Mini I/O connector (female)</p> 	0.5 m	2 x 0.16 mm <sup>2</sup>	EnDat22
1269882-xx	<p><b>APK</b> Ø 4.5 mm, 4 x (2 x 0.16 mm<sup>2</sup>); 8-pin M12 connector (female) and 6-pin Mini Delta Ribbon connector (female)</p> 	1 m to 6 m	2 x 0.16 mm <sup>2</sup>	YEC...
1275042-30	<p><b>AGK HMC 2 ECI 1319/EQI 1331/ECN 1325/EQN 1337</b> 2 x ETFE twisted single wires with wire protecting sleeve (communication); 12-pin PCB connector and 8-pin HMC 2 M23 SpeedTEC angle flange socket (male), without shield</p> 	0.30 m	0.15 mm <sup>2</sup>	E30-R2
1275291-xx	<p><b>APK HMC 2</b> PUR hybrid cable Ø 11 mm, 1.5 mm<sup>2</sup> power wires with outer shield, orange (2 x 0.25 mm<sup>2</sup>) + (2 x 0.75 mm<sup>2</sup>) + (4 x 1.5 mm<sup>2</sup>); 8-pin M23 SpeedTEC straight connector (female) and 3-pin female header (power); 4-pin male header (brake); 15-pin D-sub connector (male, for communication); also usable as a testing cable (with SA 1210 adapter) for the PWM 21.</p> 	10 m 25 m 50 m	0.25 mm <sup>2</sup>	E30-R2

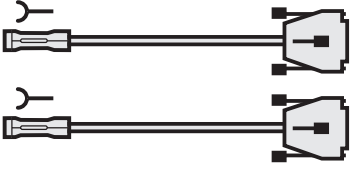
ID		Length	A <sub>p</sub>	Use with
1279881-xx	<p><b>APK HMC 2</b> PUR hybrid cable (Ø 9.3 mm, 0.5 mm<sup>2</sup>), power wires with external shield, orange, (2 x 0.14 mm<sup>2</sup>) + (2 x 0.34 mm<sup>2</sup>) + (4 x 0.5 mm<sup>2</sup>); 8-pin M12 SpeedTEC straight connector (female) and 3-pin female header (power); 4-pin male header (brake); 15-pin D-sub connector (male, for communication); also usable as a testing cable with SA 1210 adapter for the PWM 21</p> 	10 m 25 m 50 m	0.14 mm <sup>2</sup>	E30-R2
1279930-15	<p><b>AGK HMC 2 ECI 1119/EQI 1131</b> 2 x ETFE twisted single wires (communication); 15-pin PCB connector; 8-pin HMC 2 M12 SpeedTEC angle flange socket (male); 2 x ETFE single wires with heat-shrink tubing and 2-pin connector (male, for temperature), without shield</p> 	0.15 m	0.15 mm <sup>2</sup>	E30-R2
1289303-03	<p><b>VBK</b>, spiral cable, 1 x (4 x 0.09 mm<sup>2</sup>) + 4 x 0.16 mm<sup>2</sup>; 8-pin M12 connector (female) and unstripped cable end</p> 	3 m	0.16 mm <sup>2</sup>	TS/TT
1290942-xx	<p><b>APK</b> PUR Ø 6 mm, 2 x (2 x 0.09 mm<sup>2</sup>) + 2 x (2 x 0.16 mm<sup>2</sup>); 12-pin M12 quick connector and 8-pin Type II Mini I/O connector (female)</p> 	1 m to 50 m	2 x 0.16 mm <sup>2</sup>	EnDat22
1297222-xx	<p><b>APK</b> PUR Ø 6 mm, 2 x (2 x 0.09 mm<sup>2</sup>) + 2 x (2 x 0.16 mm<sup>2</sup>); 9-pin M23 connector (female) and 8-pin Type II Mini I/O connector (female)</p> 	1 m to 50 m	2 x 0.16 mm <sup>2</sup>	EnDat22
1302347-xx	<p><b>AGK HMC 2 ECI 1119/EQI 1131</b> 2 x ETFE twisted single wires (communication); 15-pin PCB connector and stripped cable end; 2 x ETFE single wires with heat-shrink tubing (temperature sensor), without shield</p> 	0.15 m 0.30 m	0.15 mm <sup>2</sup>	E30-R2
1302701-30	<p><b>AGK HMC 2 ECI 1319/EQI 1331/ECN 1325/EQN 1337</b> 2 x ETFE twisted single wires with wire protecting sleeve (communication); 12-pin PCB connector and stripped cable end, without shield</p> 	0.30 m	0.15 mm <sup>2</sup>	E30-R2
1302763-30	<p><b>AGK ECI 1319/EQI 1331/ECN 1325/EQN 1337</b> 2 x ETFE single wires with heat-shrink tubing (temperature sensor); 4-pin PCB connector and 2-pin connector (male), without shield</p> 	0.30 m	0.15 mm <sup>2</sup>	Temperature sensor
1311061-02	<p><b>AGK KCI 1xx Dplus</b>, PUR Ø 4.5 mm, 1 x (4 x 0.09 mm<sup>2</sup>) + 4 x 0.16 mm<sup>2</sup>; 15-pin PCB connector with strain relief and 15-pin D-sub connector (male), including 2 x 3 15-pin adapter connectors; two testing cables for PWM 21</p> 	2 m	0.09 mm <sup>2</sup>	EnDat22

# Signal cables

Signal cables are available in predefined lengths for various interfaces. These lengths are tied to a certain variant. The type of packaging also depends on the length. The wire color assignments are provided in the *Pin layouts* chapter.



ID	Cable type	Cable configuration	A <sub>P</sub>	Use with
816317-xx	PUR Ø 8 mm	4 x (2 x 0.16 mm <sup>2</sup> ) + 4 x 0.5 mm <sup>2</sup>	2 x 0.5 mm <sup>2</sup>	1 V <sub>PP</sub> TTL HTL
816322-xx	PUR Ø 8 mm	(4 x 0.16 mm <sup>2</sup> ) + 4 x (2 x 0.16 mm <sup>2</sup> ) + 4 x 0.5 mm <sup>2</sup>	2 x 0.5 mm <sup>2</sup>	EnDat01 EnDat02
816323-xx	PUR Ø 6 mm	6 x (2 x 0.19 mm <sup>2</sup> )	2 x 0.19 mm <sup>2</sup>	1 V <sub>PP</sub> TTL HTL
816327-xx	PUR Ø 8 mm	1 x (4 x 0.16 mm <sup>2</sup> ) + (4 x 1.0 mm <sup>2</sup> )	2 x 1.0 mm <sup>2</sup>	Fanuc... Mit...
1150200-xx	PUR Ø 6 mm	2 x (2 x 0.09 mm <sup>2</sup> ) + 2 x (2 x 0.16 mm <sup>2</sup> )	2 x 0.16 mm <sup>2</sup>	EnDat22 EnDat21 Fanuc... Mit... Pana... YEC...

Variant	Packaging	Length
-01	Bundle in bag	10 m
-02	Bundle in bag	20 m
-04	Bundle on cardboard core	100 m

# Connecting elements

## M12 and M23 connecting elements

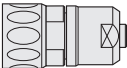
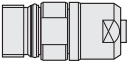
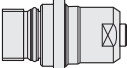
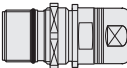
Loose connecting elements in solder and crimp versions (if needed) are available for the following connecting element types: M12 and M23. Models in D-sub, HMC 2, and HMC 6 versions are also available as special accessories.

Model	Number of poles	Type	Contact	Type of contact	
<b>M12</b> 	8-pin	Connector	Female	Solder	
		Coupling	Male	Solder	
	8-pin	Adapter connector	Wall duct (1:1)		
<b>M23</b> <b>Connector</b>  <b>Coupling</b>  <b>Mounted coupling with flange</b>  <b>Mounted coupling with central fastening</b>  <b>Flange socket</b> 	7-pin	Connector	Male	Solder	
			Female	Solder	
		Coupling	Female	Solder	
		9-pin	Connector	Male	Solder
				Female	Solder
			Coupling	Male	Solder
			Female	Solder	
	Mounted coupling with flange		Male	Solder	
			Female	Solder	
	12-pin	Flange socket	Male	Solder	
			Female	Solder	
		12-pin	Connector	Male	Solder
				Female	Solder
			Mounted connector	Female	Solder
			Coupling	Male	Solder
				Female	Solder
			Mounted coupling with flange	Male	Solder
			Male	Crimp	
			Female	Solder	
		Mounted coupling with central fastening	Male	Solder	
		17-pin	Flange socket	Male	Solder
			Female	Solder	
	Adapter connector		Connector (female) and connector (male)		
	17-pin		Connector	Male	Crimp
				Female	Crimp
			Mounted connector	Female	Crimp
			Coupling	Male	Crimp
					Crimp (1 mm <sup>2</sup> )
Mounted coupling with flange			Male	Crimp	
	Female		Crimp		
Mounted coupling with central fastening	Male	Crimp			
21-pin	Flange socket	Male	Crimp		
		Female	Crimp		
	Assembly tool				
	21-pin	Connector	Male	Crimp	
			Female	Crimp	
		Coupling	Male	Crimp	
Flange socket		Male	Crimp		
	Female	Crimp			

ID for listed cable diameters					
xx	3.7 mm	4.5 mm	6.00 mm	8.00 mm	(A) = 4.5 to 8.5 mm (B) = 6 to 10 mm
		582180-01			
		582180-02			
1142270-01					
			291697-14	291697-15	
				291697-13	
			291698-09		
		291697-02	291697-03	291697-04	
			291697-16	291697-01	
			291698-42	291698-24	
			291698-11	291698-01	
			291698-16		
			291698-15	291698-06	
315892-05					
315892-06					
		291697-06	291697-07	291697-08	
	291697-46	291697-47	291697-48	291697-49	
			291697-17	291697-05	
			291697-42		
	291698-38	291698-14	291698-03	291698-04	
			291698-12	291698-02	
		291698-23	291698-08	291698-31	
	291698-52	291698-53	291698-54	291698-55	
			291698-17	291698-07	
					741045-04 (A) 741045-01 (B)
315892-07					
315892-08					
373848-01					
				291697-27	
				291697-26	
			291697-36	291697-40	
		291698-49	291698-50	291698-27	
		291698-25	291698-26		
		291698-43	291698-41	291698-29	
				291698-35	
					741045-05 (A) 741045-02 (B)
315892-09					
315892-10					
236148-02					
				291697-31	
				291697-30	
				291698-30	
315892-11					
315892-12					

# D-sub and HMC 6 connecting elements

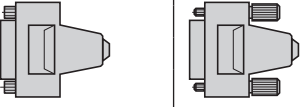
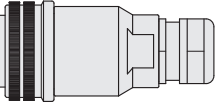
Model	Number of poles	Type	Contact	Type of contact
	15-pin	Connector	Female	Solder
	9-pin	Connector for external inputs on the IK 220	Female	Solder
	15-pin	Connector	Female	Solder
	25-pin	Connector for ND 200 switching inputs/ outputs	Male Female	Solder Solder
<b>M17 connector</b>	7-pin	Service pack Connector for EIB 5200 series	Female	Crimp
	17-pin	Connector	Female	Solder

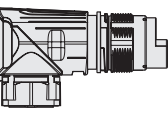
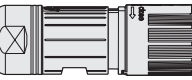
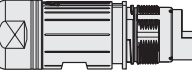
Model	Number of poles	Type	Contact	Type of contact
<b>M23</b> <b>Flange socket</b> <b>SpeedTEC</b> 	7-pin	<i>Service pack</i> Flange socket for HMC 6 Flange with bolt circle Ø 28 mm incl. contacts, contact insert, and dust protection cap <b>without</b> communication element (see AGK) 2.5 mm <sup>2</sup> power wires	Male	Crimp
		<i>Service pack</i> Flange socket for HMC 6 Flange with bolt circle Ø 32 mm incl. contacts, contact insert, and dust protection cap <b>without</b> communication element (see AGK) 2.5 mm <sup>2</sup> power wires	Male	Crimp
<b>Connector</b> <b>SpeedTEC</b> 	7-pin + 6-pin	<i>Service pack</i> Connector for HMC 6 incl. contacts, contact insert, and communication element 1.5 mm <sup>2</sup> power wires	Female	Crimp
		<i>Service pack</i> Connector for HMC 6 incl. contacts, contact insert, and communication element 4.0 mm <sup>2</sup> power wires	Female	Crimp
<b>Coupling</b> <b>SpeedTEC</b> 	7-pin + 6-pin	<i>Service pack</i> Coupling for HMC 6 incl. contacts, contact insert, and communication element 1.5 mm <sup>2</sup> power wires	Male	Crimp
		<i>Service pack</i> Coupling for HMC 6 incl. contacts, contact insert, and communication element 4.0 mm <sup>2</sup> power wires	Male	Crimp

SpeedTEC is a registered trademark of TE Connectivity Industrial GmbH.

ID for listed cable diameters					
xx	3.7 mm	4.5 mm	6.00 mm	8.00 mm	(C) = 9.5 to 12 mm
315650-14					
315650-02					
315650-04					
315650-05					
315650-06					
					1268541-01 (C)
				1094831-01	

ID for listed cable diameters		
xx	13.6 mm Cable clamping range: Ø 9.5 mm to 14.5 mm	16.6 mm Cable clamping range: Ø 14 mm to 17 mm
1043027-01		
1043027-02		
	1075255-01	
		1075255-02
	1084549-01	
		1084549-02

# HMC 2 connecting elements

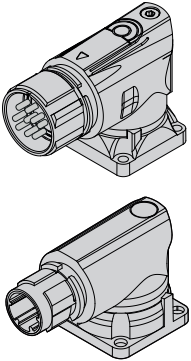
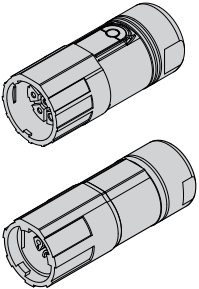
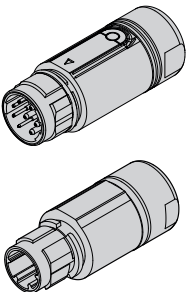
Model	Number of poles	Type	Contact	Type of contact
<b>Flange socket SpeedTEC</b> 	8-pin	<i>Service pack</i> Flange socket for HMC 2 M23 SpeedTEC angle flange socket Bolt hole circle (Ø 28 mm), including 8-pin contact insert and male contacts: 4 x Ø 2.0 mm and 4 x Ø 1.0 mm (for hybrid cable (Ø 11 mm))	Male	Crimp
		<i>Service pack</i> Flange socket for HMC 2 M12 SpeedTEC angle flange socket Bolt hole circle (Ø 23.75 mm), including 8-pin contact insert and male contacts: 4 x Ø 1.0 mm and 4 x Ø 0.6 mm (for hybrid cable (Ø 9.3 mm))	Male	Crimp
<b>Connector SpeedTEC</b> 	8-pin	<i>Service pack</i> Connector for HMC 2 M23 SpeedTEC connector, including 8-pin contact insert and male contacts: 4 x Ø 2.0 mm and 4 x Ø 1.0 mm (for hybrid cable (Ø 11 mm))	Female	Crimp
		<i>Service pack</i> Connector for HMC 2 M12 SpeedTEC connector, including 8-pin contact insert and female contacts: 4 x Ø 1.0 mm and 4 x Ø 0.6 mm (for hybrid cable (Ø 9.3 mm))	Female	Crimp
<b>Coupling SpeedTEC</b> 	8-pin	<i>Service pack</i> Coupling for HMC 2 M23 SpeedTEC coupling, including 8-pin contact insert and male contacts: 4 x Ø 2.0 mm and 4 x Ø 1.0 mm (for hybrid cable (Ø 11 mm))	Male	Crimp
		<i>Service pack</i> Coupling for HMC 2 M12 SpeedTEC coupling including 8-pin contact insert and male contacts: 4 x Ø 1.0 mm and 4 x Ø 0.6 mm (for hybrid cable (Ø 9.3 mm))	Male	Crimp







SpeedTEC is a registered trademark of TE Connectivity Industrial GmbH

ID for listed cable diameters		
xx	11 mm Cable clamping range: Ø 9.5 mm to 14.5 mm	9.3 mm Cable clamping range: Ø 8.7 mm to 9.9 mm
1304347-01		
1304347-02		
	1305176-01	
		1305176-02
	1305283-01	
		1305283-02

# Pin layouts

## EnDat (E30-R2)

### Pin layout for the hybrid motor cable with M12 connector technology

	Encoder		Motor					
	Power supply / Serial data transfer		Brake		Power			
 M12	<b>A</b>	<b>B</b>	<b>C</b>	<b>D</b>	<b>1</b>	<b>2</b>	<b>3</b>	<b>4</b>
 15	<b>8</b>	<b>15</b>	/	/	/	/	/	/
 4	/	/	<b>4</b>	<b>3</b>	/	/	/	/
 3	/	/	/	/	<b>U</b>	<b>V</b>	<b>W</b>	/
	/	/	/	/	/	/	/	<b>Earth</b>
	<b>P_SD+<sup>1)</sup></b>	<b>P_SD-<sup>1)</sup></b>	<b>Brake+</b>	<b>Brake-</b>	<b>U</b>	<b>V</b>	<b>W</b>	<b>PE</b>
 *	Blue	White	Black 5	Black 6	Black 1	Black 2	Black 3	Yellow/Green

\* Note the different color assignments between output cables versus adapter cables and connecting cables

<sup>1)</sup> Power supply voltage and data: P\_SD+ contains U<sub>P</sub> (power supply voltage); P\_SD- contains 0 V

The HMC 2 hybrid motor cable has three cable shields (an outer shield, a shield for the encoder wires, and a shield for the brake wires). The cable shields are bonded with the M12 SpeedTEC connector housing.

Vacant pins or wires must not be assigned.

SpeedTEC is a registered trademark of TE Connectivity Industrial GmbH.

#### ① 8-pin







M12



#### ② ③ ④

PWM 21  
or  
servo controller

## Pin layout for the hybrid motor cable with M23 connector technology

Encoder		Motor						
Power supply / Serial data transfer		Brake		Power				
	<b>A</b>	<b>B</b>	<b>C</b>	<b>D</b>	<b>1</b>	<b>4</b>	<b>3</b>	<b>2</b>
	<b>8</b>	<b>15</b>	/	/	/	/	/	/
	/	/	<b>4</b>	<b>3</b>	/	/	/	/
	/	/	/	/	<b>U</b>	<b>V</b>	<b>W</b>	/
	/	/	/	/	/	/	/	<b>Earth</b>
	<b>P_SD+</b> <sup>1)</sup>	<b>P_SD-</b> <sup>1)</sup>	<b>Brake+</b>	<b>Brake-</b>	<b>U</b>	<b>V</b>	<b>W</b>	<b>PE</b>
	Gray	Pink	Black 5	Black 6	Black 1	Black 2	Black 3	Yellow/Green

\* Note the different color assignments between output cables versus adapter cables and connecting cables

<sup>1)</sup> Power supply voltage and data: P\_SD+ contains U<sub>P</sub> (power supply voltage); P\_SD- contains 0 V

The HMC 2 hybrid motor cable has three cable shields (an outer shield, a shield for the encoder wires, and a shield for the brake wires). The cable shields are bonded to the M23 SpeedTEC connector housing.

Vacant pins or wires must not be used.

SpeedTEC is a registered trademark of TE Connectivity Industrial GmbH.

### ① 8-pin

M23



### ② ③ ④

PWM 21

or  
servo controller

# EnDat (EnDat22)

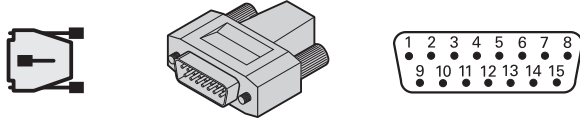
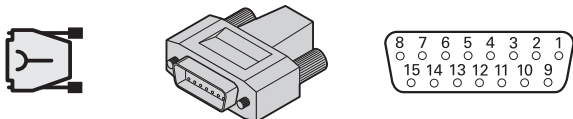
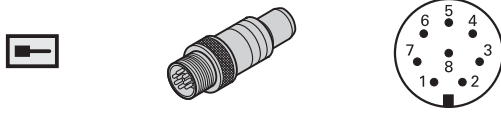
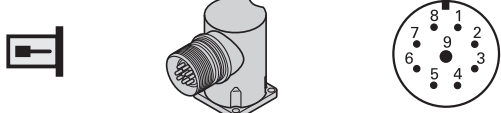
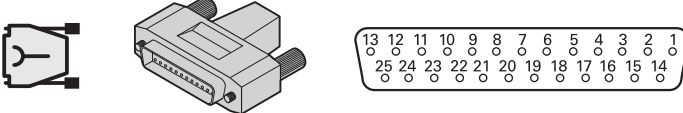
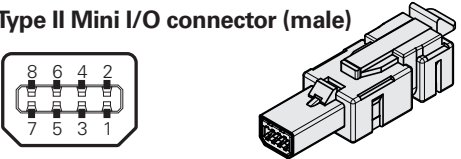
① 15-pin D-sub connector	② 15-pin D-sub connector							
								
③ 8-pin M12 coupling	④ 9-pin M23 flange socket							
								
⑤ 25-pin D-sub connector	⑥ 8-pin Type II Mini I/O connector (male)							
								
	Power supply	Serial data transmission						
①	4	12	2	10	5	13	8	15
②	1	9	2	11	5	8	14	15
③	8	2	5	1	3	4	7	6
④	3	7	4	8	5	6	1	2
⑤	1	14	2	16	15	23	10	12
⑥	2	1	6	5	4	3	8	7
*	Brown/Green	Blue	White/Green	White	Gray	Pink	Violet	Yellow
	<b>U<sub>P</sub></b>	<b>Sensor</b> U <sub>P</sub>	<b>0V</b>	<b>Sensor</b> 0V	<b>DATA</b>	<b>DATA</b>	<b>CLOCK</b>	<b>CLOCK</b>

\* Note the different color assignments between output cables versus adapter cables and connecting cables

**Cable shield** connected to housing; **U<sub>P</sub>** = Power supply voltage

**Sensor:** The sense line is connected in the encoder with the corresponding power line.

Vacant pins or wires must not be used!

## ① 15-pin

ND 280  
ND 287  
EIB 74x  
PWM 21  
PWT 101  
PT 8000  
GC 2000  
EIB 3391Y

## ② 15-pin

TNC  
(SMC 40)

## ③ 8-pin

M12

## ④ 9-pin

M23









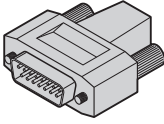
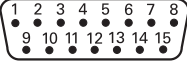

## ⑤ 25-pin

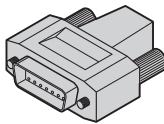
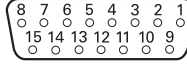
TNC  
EIB 5181

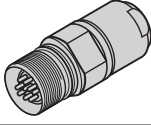
## ⑥ 8-pin

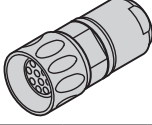
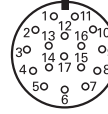
TNC

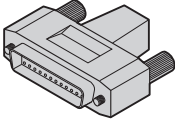
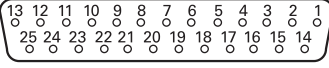
# EnDat (EnDat01/EnDat02)

<b>① 15-pin D-sub connector</b>   					<b>② 15-pin D-sub connector</b>   											
<b>③ 17-pin M23 coupling</b>   					<b>③ 17-pin M23 connector</b>   											
<b>④ 25-pin D-sub connector</b>   																
	Power supply					Incremental signals					Serial data transmission					
①	4	12	2	10	6	1	9	3	11	5	13	8	15	/	/	
②	1	9	2	11	13	3	4	6	7	5	8	14	15	/	/	
③ <sup>2)</sup>	7	1	10	4	11 <sup>1)</sup>	15	16	12	13	14	17	8	9	5 <sup>3)</sup>	6 <sup>3)</sup>	
④	1	14	2	16	/	3	4	6	7	15	23	10	12	/	/	
 *	Brown/ Green	Blue	White/ Green	White	/	Green/ Black	Yellow/ Black	Blue/ Black	Red/ Black	Gray	Pink	Violet	Yellow	Green	Brown	
	<b>U<sub>P</sub></b>	<b>Sensor</b> U <sub>P</sub>	<b>0V</b>	<b>Sensor</b> 0V	Internal shield	<b>A+</b>	<b>A-</b>	<b>B+</b>	<b>B-</b>	<b>DATA</b>	<b>DATA</b>	<b>CLOCK</b>	<b>CLOCK</b>	<b>T+</b>	<b>T-</b>	

\* Note the different color assignments between output cables versus adapter cables and connecting cables

**Cable shield** connected to housing; **U<sub>P</sub>** = Power supply voltage

**Sensor:** The sense line is connected in the encoder with the corresponding power line.

Vacant pins or wires must not be used!

<sup>1)</sup> Only ID 309778-xx, ID 323897-xx, ID 324544-xx, ID 332115-xx, ID 509667-xx

<sup>2)</sup> Motors from HEIDENHAIN have a different pin layout for the connection to the TNC. For suitable cables, see the cable overview in the TNC brochure *Information for the Machine Tool Builder*.

<sup>3)</sup> Only ID 309778-xx, ID 323897-xx, ID 332201-01, ID 509667-xx (deviating colors), ID 606079-01

## ① 15-pin

ND 280  
ND 287  
EIB 74x  
PWM 21  
PWT 101

## ② 15-pin

TNC  
IK 220  
(SMC 40)

## ③ 17-pin

M23  
(SME 125)  
(SME 25)

## ④ 25-pin

TNC  
EIB 5181

## Special cables

### ④ 25-pin D-sub connector

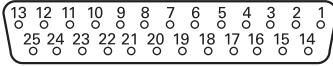
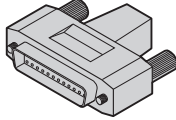

	Power supply				Incremental signals				Serial data transmission					
④	1	14	2	16	3	4	6	7	15	23	10	12	13 <sup>1)</sup>	25 <sup>1)</sup>
 *	Brown/ Green	Blue	White/ Green	White	Green/ Black	Yellow/ Black	Blue/ Black	Red/ Black	Red	Black	Green	Brown	Yellow	Violet
	<b>U<sub>P</sub></b>	<b>Sensor</b> U <sub>P</sub>	<b>0V</b>	<b>Sensor</b> 0V	<b>A+</b>	<b>A-</b>	<b>B+</b>	<b>B-</b>	<b>DATA</b>	<b>DATA</b>	<b>CLOCK</b>	<b>CLOCK</b>	<b>T+</b>	<b>T-</b>

\* Note the different color assignments between output cables versus adapter cables and connecting cables

**Cable shield** connected to housing; **U<sub>P</sub>** = Power supply voltage

**Sensor:** The sense line is connected in the encoder with the corresponding power line.



Vacant pins or wires must not be used!

<sup>1)</sup> Only ID 509667-xx

### ④ 25-pin

TNC  
EIB 5181

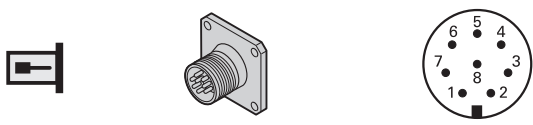
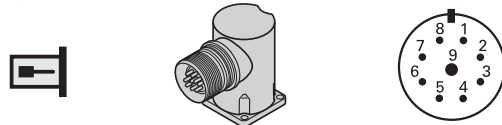
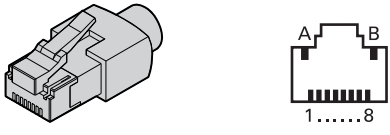
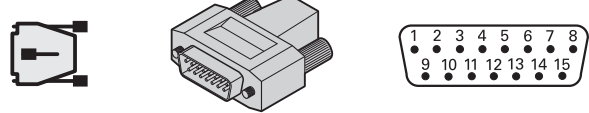
# DRIVE-CLiQ

<b>① 8-pin M12 flange socket</b> 		<b>② 9-pin M23 flange socket</b> 				
<b>③ RJ45</b> 		<b>④ 15-pin D-sub connector</b> 				
	Power supply		Serial data transmission			
①	1	5	3	4	7	6
②	8	4	5	6	1	2
③	A	B	3	6	1	2
④	10	2	8	15	5	13
 *	Red	Black	Green	Yellow	Pink	Blue
	<b>U<sub>P</sub></b>	<b>0V</b>	<b>RXP</b>	<b>RXN</b>	<b>TXP</b>	<b>TXN</b>

\* Note the different color assignments between output cables versus adapter cables and connecting cables





① 8-pin  
M12

② 9-pin  
M23

③ RJ45  
IP20  
IP67

④ 15-pin

# Fanuc purely serial

	Power supply					Serial data transmission			
① 15-pin Fanuc connector	9	18/20	12	14	16	1	2	5	6
② 17-pin M23 coupling	7	1	10	4	Housing	14	17	8	9
③ 8-pin M12 coupling	8	2	5	1	Housing	3	4	7	6
④ 15-pin D-sub connector	4	12	2	10	Housing	5	13	8	15
	Brown/Green	Blue	White/Green	White	/	Gray	Pink	Violet	Yellow
	<b>Up</b> 	<b>Sensor</b> Up 	<b>0V</b> 	<b>Sensor</b> 0V 	Shield	<b>Serial Data</b>	<b>Serial Data</b>	<b>Request</b>	<b>Request</b>

**Up** = Power supply

**Sensor:** The sense line is connected in the encoder with the corresponding power line.

Vacant pins or wires must not be used!

For the shield connection of the Fanuc connector, see also *General electrical information* in the *Interfaces of HEIDENHAIN Encoders* brochure.

## ① 15-pin

Fanuc α  
Fanuc αi

## ② 17-pin



M23

## ③ 8-pin

M12

## ④ 15-pin

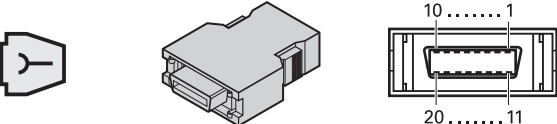
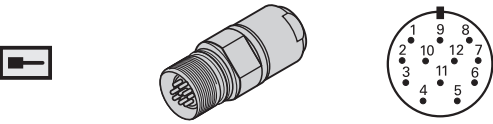
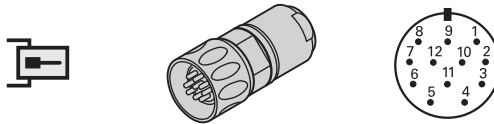
# Fanuc TTL

<b>⑤ 15-pin Fanuc connector</b> 													
<b>⑥ 12-pin M23 coupling</b> 							<b>⑥ 12-pin M23 connector</b> 						
	Power supply				Incremental signals						Other signals		
⑤	9	18+20	12	14	1	2	3	4	5	6	8	7	16
⑥	12	2	10	11	5	6	8	1	3	4	7	9	Housing
	Brown/ Green	Blue	White/ Green	White	Brown	Green	Gray	Pink	Red	Black	/	/	/
	$U_P$	Sensor $U_P$	0V	Sensor 0V	$U_{a1}$	$\overline{U}_{a1}$	$U_{a2}$	$\overline{U}_{a2}$	$U_{a0}$	$\overline{U}_{a0}$	Vacant	Vacant	Shield

$U_P$  = Power supply

**Sensor:** The sense line is connected in the encoder with the corresponding power line.

Vacant pins or wires must not be used!



## ⑤ 15-pin

Fanuc TTL

## ⑥ 12-pin

M23

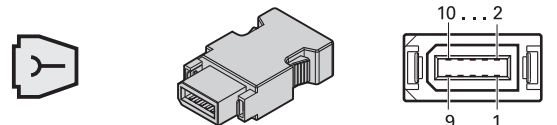
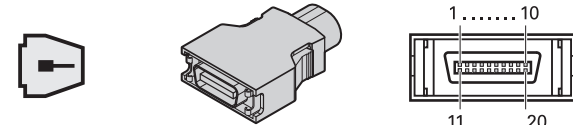
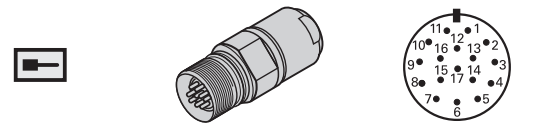
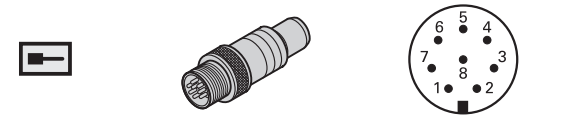
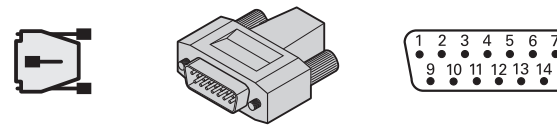
# Mitsubishi

<p>① 10-pin Mitsubishi connector</p> 	<p>② 20-pin Mitsubishi connector</p> 							
<p>③ 17-pin M23 coupling</p> 	<p>④ 8-pin M12 coupling</p> 							
<p>⑤ 15-pin D-sub connector</p> 								
	Power supply	Serial data transmission						
①	1	/	2	/	7	8	3	4
②	20	19	1	11	6	16	7	17
③	7	1	10	4	14	17	8	9
④	8	2	5	1	3	4	7	6
⑤	4	12	2	10	5	13	8	15
	Brown/Green	Blue	White/Green	White	Gray	Pink	Violet	Yellow
Mit03-4	<b>U<sub>P</sub></b>	<b>Sensor</b> U <sub>P</sub>	<b>0V</b>	<b>Sensor</b> 0V	<b>Serial Data</b>	<b>Serial Data</b>	<b>Request Frame</b>	<b>Request Frame</b>
Mit02-2	<b>U<sub>P</sub></b>	<b>Sensor</b> U <sub>P</sub>	<b>0V</b>	<b>Sensor</b> 0V	Vacant	Vacant	<b>Request/ Data</b>	<b>Request/ Data</b>

**Cable shield** connected to housing; **U<sub>P</sub>** = Power supply voltage

**Sensor:** The sense line is connected in the encoder with the corresponding power line.

Vacant pins or wires must not be used!

① 10-pin

Mitsubishi

② 20-pin

Mitsubishi

③ 17-pin





M23

④ 8-pin

M12

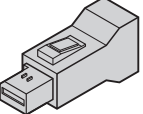
⑤ 15-pin

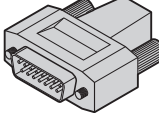
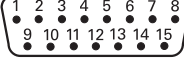
# Panasonic

① 10-pin Panasonic connector					② 8-pin M12 coupling				
									
③ 15-pin D-sub connector									
									
	Power supply				Serial data transmission				
①	1	1	2	2	/	/	3	4	
②	8	2	5	1	3	4	7	6	
③	4	12	2	10	5	13	8	15	
	Brown/Green	Blue	White/Green	White	Gray	Pink	Violet	Yellow	
	<b>U<sub>P</sub></b>	<b>Sensor</b> U <sub>P</sub>	<b>0V</b>	<b>Sensor</b> 0V	Reserved, do not assign	Reserved, do not assign	<b>Request/ Data</b>	<b>Request/ Data</b>	

**Cable shield** connected to housing; **U<sub>P</sub>** = Power supply voltage

**Sensor:** The sense line is connected in the encoder with the corresponding power line.

Vacant pins or wires must not be used!

## ① 10-pin



Panasonic

## ② 8-pin

M12

## ③ 15-pin

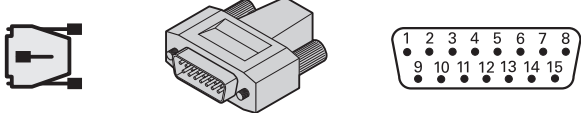
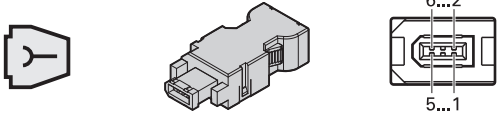
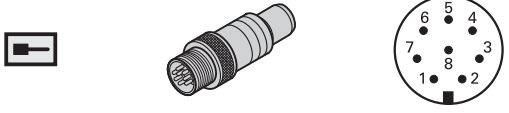

PWM 21  
PWT 101

<b>① 15-pin D-sub connector</b> 					<b>② 6-pin Yaskawa connector</b> 			
<b>③ 8-pin M12 coupling</b> 								
	Power supply				Serial data transmission			
①	4	12	2	10	/	/	8	15
②	1	1	2	2	/	/	5	6
③	8	2	5	1	/	/	7	6
	Brown/Green	Blue	White/Green	White	Gray	Pink	Violet	Yellow
	<b>U<sub>P</sub></b>	<b>Sensor</b> U <sub>P</sub>	<b>0V</b>	<b>Sensor</b> 0V	Reserved, do not assign	Reserved, do not assign	<b>DATA</b>	<b>DATA</b>

**Cable shield** connected to housing; **U<sub>P</sub>** = Power supply voltage

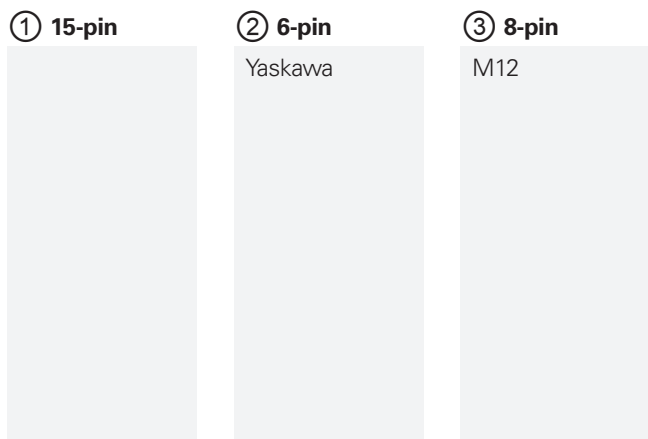
**Sensor:** The sense line is connected in the encoder with the corresponding power line.  
Vacant pins or wires must not be used!

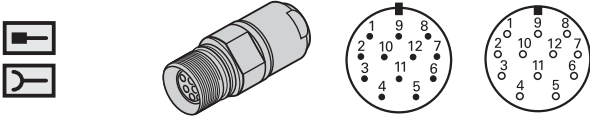
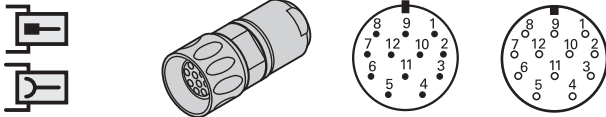
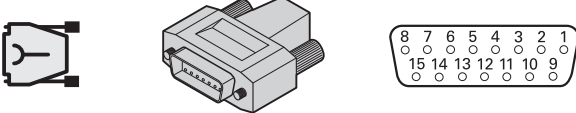
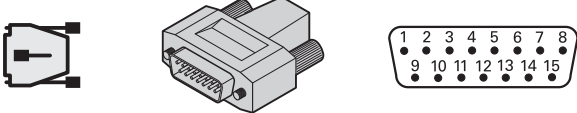
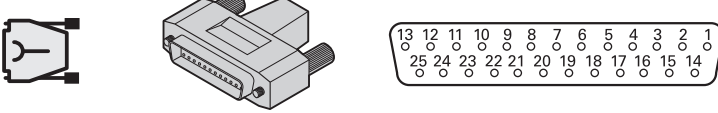

<b>① 12-pin M23 coupling</b> 					<b>① 12-pin M23 connector</b> 								
<b>② 15-pin D-sub connector</b> 					<b>③ 15-pin D-sub connector</b> 								
<b>④ 25-pin D-sub connector</b> 													
	Power supply				Incremental signals						Other signals		
①	12	2	10	11	5	6	8	1	3	4	9	7	/
②	1	9	2	11	3	4	6	7	10	12	5/8/13	14	15 <sup>1)</sup>
③	4	12	2	10	1	9	3	11	14	7	5/6/8	13	15 <sup>2)</sup>
④	1	14	2	16	3	4	6	7	17	18	5/8-13/ 15/19-25	/	/
	Brown/ Green	Blue	White/ Green	White	Brown	Green	Gray	Pink	Red	Black	/	Violet	Yellow
	<b>Up</b>	<b>Sensor</b> U <sub>P</sub>	<b>0V</b>	<b>Sensor</b> 0V	<b>A+</b>	<b>A-</b>	<b>B+</b>	<b>B-</b>	<b>R+</b>	<b>R-</b>	Vacant	Vacant	Vacant

**Shield** connected with housing; **Up** = Power supply

**Sensor:** The sense line is connected in the encoder with the corresponding power line.

Vacant pins or wires must not be used!

<sup>1)</sup> Only ID 349687-xx, ID 360974-xx, ID 335077-xx: reserved, do not use

<sup>2)</sup> Unstripped cable end with ID 310196-xx

## ① 12-pin

M23

## ② 15-pin

TNC  
IK 220







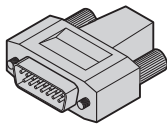
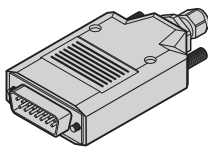
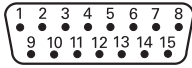

## ③ 15-pin

ND 280  
ND 287  
GC 2000  
ND 2100G  
EIB 74x  
PWM 21  
PWT 101  
PT 8000  
ND 7000  
EIB 392(x)  
IBV 3x71

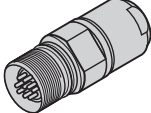
## ④ 25-pin

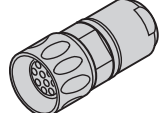
TNC  
(SMC 20)

## Special cables

③ 15-pin D-sub connector												
												
⑤ 17-pin M23 coupling					17-pin M23 connector							
												
	Power supply					Incremental signals						
③	4	12	2	10	/	1	9	3	11	14	7	
⑤ <sup>3)</sup>	7	1	10	4	11	15	16	12	13	3	2	
	Brown/ Green	Blue	White/ Green	White	/	Brown	Green	Gray	Pink	Red	Black	
	<b>Up</b>	<b>Sensor</b> Up	<b>0V</b>	<b>Sensor</b> 0V	<b>Internal shield</b>	<b>A+</b>	<b>A-</b>	<b>B+</b>	<b>B-</b>	<b>R+</b>	<b>R-</b>	
	Other signals											
③	13 <sup>2)</sup>	8 <sup>1)</sup>	6 <sup>1)</sup>	15 <sup>2)</sup>	5 <sup>2)</sup>	6	/	/	/	/	/	/
⑤ <sup>3)</sup>	/	/	/	/	/	/	14	17	9	8	5	6
	Violet	Green/ Black	Yellow/ Black	Yellow	Red/Black	Yellow/ Black	/	/	/	/	/	/
	<b>Vacant</b>	<b>H</b>	<b>L</b>	<b>Vacant</b>	<b>Vacant</b>	<b>Vacant</b>	<b>C+</b>	<b>C-</b>	<b>D+</b>	<b>D-</b>	<b>T+</b>	<b>T-</b>
	<b>DATA</b>	Vacant	Vacant	<b>CLOCK</b>	<b>Test</b>	Vacant						

**Shield** connected with housing; **Up** = Power supply

**Sensor:** The sense line is connected in the encoder with the corresponding power line.

Vacant pins or wires must not be used!

<sup>1)</sup> Only ID 354379-xx, ID 354411-xx, ID 355397-xx, ID 355398-xx

<sup>2)</sup> Only ID 735541-xx: with programming line for mounting the LIP 281

<sup>3)</sup> Only ID 323897-xx, deviating colors

**Note:** The listed devices can be connected. For information on additional data, please refer to the Product Information document of the device.





### ③ 15-pin

ND 280  
ND 287  
ND 13xx  
ND 14xx  
ND 21xx  
EIB 74x  
PWM 21  
PWT 101  
ND 7013  
ND 7013 I/O

### ⑤ 17-pin

M23

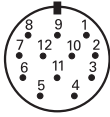
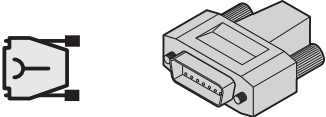
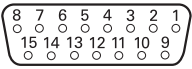
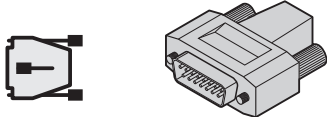
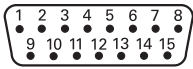
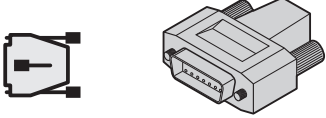
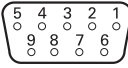
# TTL or HTL

<b>① 12-pin M23 coupling</b>  					<b>① 12-pin M23 connector</b>  								
<b>② 15-pin D-sub connector</b>  					<b>③ 15-pin D-sub connector</b>  								
<b>④ 9-pin D-sub connector</b>  													
	Power supply				Incremental signals						Other signals		
①	12	2	10	11	5	6	8	1	3	4	7	/	9 <sup>2)</sup>
②	1	9	2	11	3	4	6	7	10	12	14	5/8/13	15 <sup>2)</sup>
③	4	12	2	10	1	9	3	11	14	7	13	5/6/8	15 <sup>2)</sup>
④	7	7 <sup>3)</sup>	6	6 <sup>3)</sup>	2	3	4	5	9	8	/	/	/
	Brown/ Green	Blue	White/ Green	White	Brown	Green	Gray	Pink	Red	Black	Violet	/	Yellow
	<b>U<sub>P</sub></b>	<b>Sensor</b> U <sub>P</sub>	<b>0V</b>	<b>Sensor</b> 0V	<b>U<sub>a1</sub></b>	<b>U<sub>a1</sub></b>	<b>U<sub>a2</sub></b>	<b>U<sub>a2</sub></b>	<b>U<sub>a0</sub></b>	<b>U<sub>a0</sub></b>	<b>U<sub>aS</sub></b>	Vacant	Reserved, do not assign <sup>1)</sup>

**Cable shield** connected to housing; **U<sub>P</sub>** = Power supply voltage

**Sensor:** The sense line is connected in the encoder with the corresponding power line.

Vacant pins or wires must not be used!

<sup>1)</sup> **Exposed linear encoders:** conversion from TTL to 11 μA<sub>PP</sub> for the PWT, otherwise not assigned

<sup>2)</sup> Unstripped cable end with: ID 298429-xx, ID 309783-xx, ID 309784-xx, ID 310196-xx, ID 310199-xx

<sup>3)</sup> Only ID 617513-xx, ID 626015-xx; not with ID 617484-xx, ID 735210-xx

## ① 12-pin

M23

## ② 15-pin

## ③ 15-pin

PWM 21  
PWT 101

## ④ 9-pin

ND 5023  
GC 2000  
ND 2100G

## Special cables

### ③ 15-pin D-sub connector

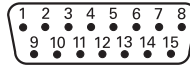
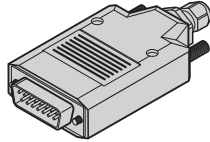
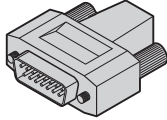

	Power supply				Incremental signals						Other signals			
③	4	12	2	10	1	9	3	11	14	7	13	8 <sup>4)</sup>	6 <sup>4)</sup>	15
	Brown/ Green	Blue	White/ Green	White	Brown	Green	Gray	Pink	Red	Black	Violet	Green/ Black	Yellow/ Black	Yellow
	<b>U<sub>P</sub></b>	<b>Sensor</b> U <sub>P</sub>	<b>0V</b>	<b>Sensor</b> 0V	<b>U<sub>a1</sub></b>	<b>Ū<sub>a1</sub></b>	<b>U<sub>a2</sub></b>	<b>Ū<sub>a2</sub></b>	<b>U<sub>a0</sub></b>	<b>Ū<sub>a0</sub></b>	<b>Ū<sub>aS</sub></b>	<b>L1</b> <sup>2)</sup> <b>H</b> <sup>3)</sup>	<b>L2</b> <sup>2)</sup> <b>L</b> <sup>3)</sup>	<b>PWT</b> <sup>1)</sup>

**Cable shield** connected to housing; **U<sub>P</sub>** = Power supply voltage

**Sensor:** The sense line is connected in the encoder with the corresponding power line.

Vacant pins or wires must not be used!

1) TTL/11 μA<sub>PP</sub> conversion for the PWT

2) Only with LIDA 4xx

3) Only with LIF 481

4) Only ID 354379-xx, ID 354411-xx, ID 355397-xx, ID 355398-xx

**Note:** The listed devices can be connected. For information on additional data, please refer to the Product Information document of the device.

### ③ 15-pin

PWM 21  
PWT 101

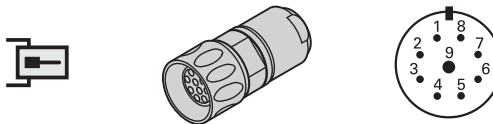
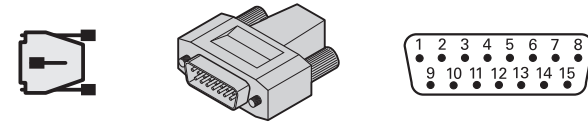
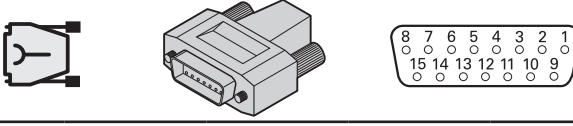
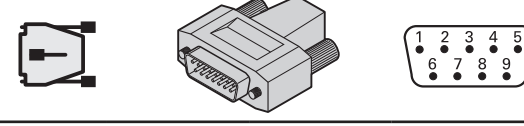
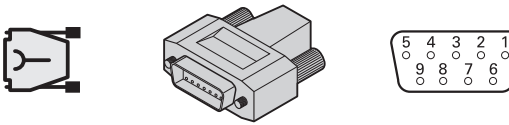
<b>① 9-pin M23 connector</b> 			<b>② 15-pin D-sub connector</b> 						
<b>③ 15-pin D-sub connector</b> 			<b>④ 9-pin D-sub connector</b> 						
<b>⑤ 9-pin D-sub connector</b> 									
	Power supply			Incremental signals					
①	3	4	9	1	2	5	6	7	8
②	4	2	6	1	9	3	11	14	7
③	1	2	13	3	4	6	7	10	12
④	7	1	6	2	3	4	5	8	9
⑤	7	2	4	6	1	8	3	9	5
	$U_P$	0V	Internal shield	$I_1+$	$I_1-$	$I_2+$	$I_2-$	$I_0+$	$I_0-$

**Cable shield** connected to housing;  $U_P$  = Power supply voltage  
 Vacant pins or wires must not be used!

**① 9-pin**  
M23



**② 15-pin**  
 ND 280  
 ND 287  
 GC 2000  
 EIB 74x  
 PWM 21  
 PWT 101  
 PT 8000  
 ND 7000

**③ 15-pin**  
IK 220

**④ 9-pin**  
ND 2100 G

**⑤ 9-pin**

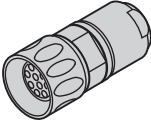



### Special cables

① 9-pin M23 connector									
									
	Power supply			Incremental signals					
①	3	4	9	1	2	5	6	7	8
 1)	Brown	White	Internal shield	Green	Yellow	Blue	Red	Gray	Pink
	<b>U<sub>P</sub></b>	<b>0V</b>	Internal shield	<b>I<sub>1+</sub></b>	<b>I<sub>1-</sub></b>	<b>I<sub>2+</sub></b>	<b>I<sub>2-</sub></b>	<b>I<sub>0+</sub></b>	<b>I<sub>0-</sub></b>

**Cable shield** connected to housing; **U<sub>P</sub>** = Power supply voltage  
 Vacant pins or wires must not be used!

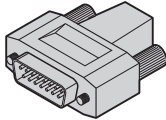
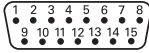
1) Only ID 309780-xx

### Adapter for 1 V<sub>PP</sub> special cables

③ 15-pin D-sub connector					③ 15-pin D-sub connector									
														
	Power supply				Incremental signals						Other signals			
③	1	9	2	11	3	4	6	7	10	12	5/8/ 13/15	14 <sup>1)</sup>	/	
	Brown/ Green	Blue	White/ Green	White	Brown	Green	Gray	Pink	Red	Black	/	Violet	Yellow	
11 μApp	<b>U<sub>P</sub></b>	<b>Sensor</b> U <sub>P</sub>	<b>0V</b>	<b>Sensor</b> 0V	<b>I<sub>1+</sub></b>	<b>I<sub>1-</sub></b>	<b>I<sub>2+</sub></b>	<b>I<sub>2-</sub></b>	<b>I<sub>0+</sub></b>	<b>I<sub>0-</sub></b>	Reserved, do not assign	Reserved, do not assign	Reserved, do not assign	
1 V <sub>PP</sub>					<b>A+</b>	<b>A-</b>	<b>B+</b>	<b>B-</b>	<b>R+</b>	<b>R-</b>				

**Cable shield** connected to housing; **U<sub>P</sub>** = Power supply voltage

**Sensor:** The sense line is connected in the encoder with the corresponding power line.

Vacant pins or wires must not be used!

1) Only on a 1 V<sub>PP</sub> output







#### ① 9-pin

M23

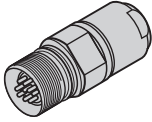
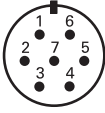
#### ③ 15-pin

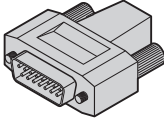
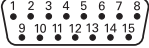
IK 220

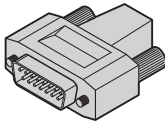
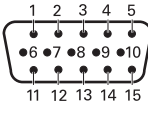
# Touch probes: SE

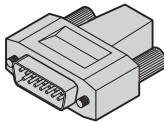
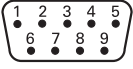
<b>① 7-pin M23 coupling</b>   					<b>② 15-pin, 2-row D-sub connector</b>   											
<b>③ 15-pin, 3-row D-sub connector</b>   					<b>④ 9-pin, 2-row D-sub connector</b>   											
	Power supply					Signals							Serial data transmission			
①	2	/	1	/	7	3	/	5	/	4	6	/	/	/	/	/
②	5, 6 <sup>1)</sup>	/	8	/	1	4	/	3	/	10	7	/	/	/	/	/
③	10	10	9	8	/	6	7	3	11	2	4	/	12	13	14	15
	U <sub>P</sub>	Sensor U <sub>P</sub>	0V	Sensor 0V	Internal shield	R(TS)	R(TT)	B(TS)	B(TT)	$\bar{S}$	$\bar{W}$	S	DATA	$\overline{DATA}$	CLOCK	CLOCK

**External shield** lies on connector housing.

**U<sub>P</sub>** = Power supply voltage; **R** = Start signal; **B** = Ready signal; **S**,  $\bar{S}$  = Trigger signal;  $\bar{W}$  = Battery warning

**Sensor:** The sense line is connected in the encoder with the corresponding power line.

Vacant pins or wires must not be used!

<sup>1)</sup> Only ID 701919-xx

## ① 7-pin

M23

## ② 15-pin





TNC

## ③ 15-pin

PLB 62xx  
UEC 11x  
UMC 11x  
or  
UEC 3xx

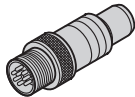
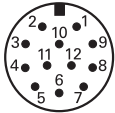
## ④ 9-pin

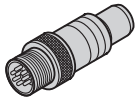
TNC

⑤ 12-pin M12 coupling					⑥ 8-pin M12 coupling								
													
	Power supply				Signals and serial data transmission								
⑤	1	/	12	/	11	5	2	10	3	4	6	7	8
⑥	1	8	5	2	/	/	/	/	3	4	6	7	/
⑤	U <sub>P</sub>	/	0V	/	R(TS)	R(TT)	B(TS)	B(TT)	S	$\bar{S}$	$\bar{W}$	SEL(0)	SEL(1)
⑥	U <sub>P</sub>	Sensor U <sub>P</sub>	0V	Sensor 0V	/	/	/	/	DATA	$\overline{DATA}$	$\overline{CLOCK}$	CLOCK	/

**External shield** lies on connector housing.

**U<sub>P</sub>** = Power supply voltage; **R** = Start signal; **B** = Ready signal; **S**,  $\bar{S}$  = Trigger signal;  $\bar{W}$  = Battery warning

**SEL(0)** = Selection 0 (depends on variant); **SEL(1)** = Selection 1 (depends on variant)

**Sensor:** The sense line is connected in the encoder with the corresponding power line.

Vacant pins or wires must not be used!

For the signal behavior in detail, please comply with the SE Mounting Instructions.

⑤ 12-pin

M12

⑥ 8-pin

M12

# Touch probes: TS

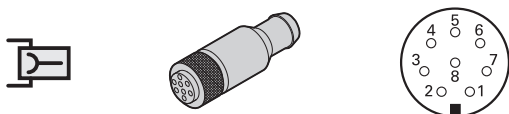
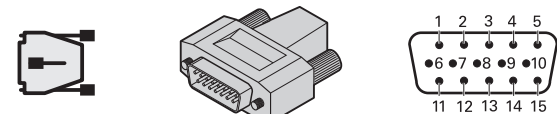
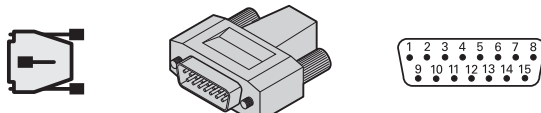
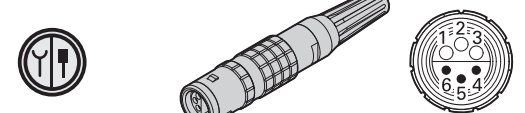
<b>① 8-pin M12 connector</b> 			<b>② 15-pin, 3-row D-sub connector</b> 					
<b>③ 15-pin, 2-row D-sub connector</b> 			<b>④ 6-pin quick connector</b> 					
	Power supply		Signals					
①	2	7	3	4	1	5	6	8
②	10	9	1	2	3	/	/	/
③	5	8	9	10	3	14 <sup>1)</sup>	11 <sup>1)</sup>	12 <sup>1)</sup>
④	3	1	5	6	3/4	/	/	/
	<b>U<sub>P</sub></b>	<b>0V</b>	<b>S</b>	<b><math>\bar{S}</math></b>	<b>B</b>	<b>Trigger NO</b>	<b>Trigger NC</b>	<b>Trigger 0V</b>

**External shield** lies on connector housing.

<sup>1)</sup> Not with ID 274543-xx

**U<sub>P</sub>** = Power supply voltage; **B** = Ready signals; **S**,  **$\bar{S}$**  = Trigger signal

Trigger = Floating switching outputs (NC = normally closed, NO = normally open)

Vacant pins or wires must not be used!

## ① 8-pin

M12

## ② 15-pin

PLB 62xx  
UEC 11x  
UMC 11x

## ③ 15-pin

TNC

## ④ 6-pin

# Touch probes: TT

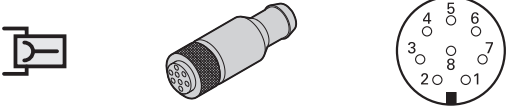
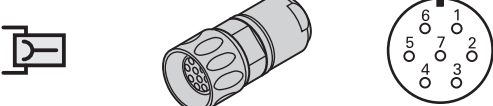
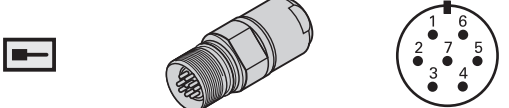
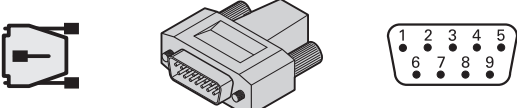
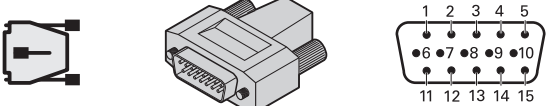
<p>① 8-pin M12 connector</p> 	<p>② 7-pin M23 connector</p> 				
<p>② 7-pin M23 coupling</p> 	<p>③ 9-pin D-sub connector</p> 				
<p>④ 15-pin, 3-row D-sub connector</p> 					
	Power supply		Signals		
①	2	7	3	4	1
②	2+5	1	3	4	6
③	4	2	8	9	1
④	10	9	1	2	11
	$U_P$	0V	S	$\bar{S}$	B

External shield lies on connector housing.

$U_P$  = Power supply voltage; **B** = Ready signals; **S**,  $\bar{S}$  = Trigger signal

Vacant pins or wires must not be used!

① 8-pin

M12

② 7-pin

M23

③ 9-pin

TNC  
(>LE 4xx)

④ 15-pin

PLB 62xx  
UEC 11x  
UMC 11x

# Special cables for touch probes

① Stripped cable end												
												
	Power supply		Signals									
① <sup>1)</sup>	Brown/ Green	White/ Green	Blue	White	Green	Brown	Gray	Pink	Violet	Yellow	Red	Black
① <sup>2)</sup>	Brown	White	Yellow	/	Gray	/	/	Green	Blue	/	/	/
	<b>U<sub>P</sub></b>	<b>0V</b>	<b>R(TS)</b>	<b>R(TT)</b>	<b>B(TS)</b>	<b>B(TT)</b>	<b>S</b>	<b><math>\bar{S}</math></b>	<b><math>\bar{W}</math></b>	<b>/</b>	<b>SEL(0)</b>	<b>SEL(1)</b>

**External shield** lies on connector housing.

**U<sub>P</sub>** = Power supply voltage; **R** = Start signal; **B** = Ready signal; **S**,  **$\bar{S}$**  = Trigger signal;  **$\bar{W}$**  = Battery warning

**SEL(0)** = Selection 0 (depends on variant); **SEL(1)** = Selection 1 (depends on variant)

Vacant pins or wires must not be used!

<sup>1)</sup> Only ID 801285-xx, ID 1217425-xx without W signal

<sup>2)</sup> Only ID 310193-xx

① Stripped cable end								
								
	Power supply		Signals					
① <sup>1)</sup>	Blue	Violet	Gray	Pink	White	White/Green	Yellow	Brown/Green
① <sup>2)</sup>	Gray	White/Green	Green	Yellow	Pink	/	/	/
① <sup>3)</sup>	Brown/Green + Gray	White/Green	Brown	Green	Pink	/	/	/
	<b>U<sub>P</sub></b>	<b>0V</b>	<b>S</b>	<b><math>\bar{S}</math></b>	<b>B</b>	<b>Trigger NO</b>	<b>Trigger NC</b>	<b>Trigger 0V</b>

**External shield** lies on connector housing.

**U<sub>P</sub>** = Power supply voltage; **B** = Ready signals; **S**,  **$\bar{S}$**  = Trigger signal

Trigger = Floating switching outputs (NC = normally closed, NO = normally open)

Vacant pins or wires must not be used!

<sup>1)</sup> Only ID 634265-xx, ID 606317-xx, ID 634265-xx, ID 1083190-xx, ID 1259406-xx, ID 1289303-xx

<sup>2)</sup> Only ID 274544-xx

<sup>3)</sup> Only ID 310194-xx

## ① Stripped cable end

F\*/S/M

# HEIDENHAIN

Mastering nanometer accuracy



## HEIDENHAIN

DR. JOHANNES HEIDENHAIN GmbH  
Dr.-Johannes-Heidenhain-Straße 5  
83301 Traunreut, Germany  
☎ +49 8669 31-0  
☎ +49 8669 32-5061  
info@heidenhain.de  
www.heidenhain.com



HEIDENHAIN  
worldwide